

EMC TEST REPORT



For Electromagnetic Interference of

Report Reference No.: EA1904055E 01001

Engineer (name + signature): Wite Chen 

Approved by (name + signature).....: Alan He 

Date of Receipt of EUT: Apr. 10, 2019

Date of Test: Apr. 10, 2019 to Apr. 18, 2019

Date of issue: Apr. 18, 2019

Testing Laboratory.....: Dongguan Anci Electronic Technology Co., Ltd.

Address: 1-2 Floor, Building A, No.11, Headquarters 2 Road, Songshan Lake
Hi-tech Industrial Development Zone, Dongguan City, Guangdong,
China

Applicant's name: V-TAC Exports Limited

Address: Room No 301, Kam On Building, 176A Queens Road Central,
Central, Hong Kong

Manufacturer: V-TAC Exports Limited

Address: Room No 301, Kam On Building, 176A Queens Road Central,
Central, Hong Kong

First Factory's name.....: V-TAC Exports Limited

Address.....: Room No 301, Kam On Building, 176A Queens Road Central,
Central, Hong Kong

Test specification:

| | |
|----------------------------|--|
| EUT description.....: | USB DATA CABLE |
| Trade Mark.....: |  |
| Model/Type reference | VT-5301, VT-5302, VT-5321, VT-5322, VT-5331, VT-5334, VT-5341, VT-5342, VT-5352, VT-5361, VT-5362, VT-5552, VT-5332, VT-5333, VT-5542, VT-5543 |
| Test Sample.....: | VT-5301 |
| Ratings | Input rating: DC 5V |
| Tested Power.....: | I/P: DC 5V. |
| Standards | EN 55032: 2015 EN 55035: 2017 |

The device described above was tested by Dong Guan Anci Electronic Technology Co., Ltd. to determine the maximum emission levels emanated from the device and severity levels of the device endure and its performance criterion. The measurement results are contained in this test report and Dong Guan Anci Electronic Technology Co., Ltd. assumes full responsibility for the accuracy and completeness of these measurements. This report shows the EUT is technically compliance with the above official standards.

This report applies to the above sample only and shall not be reproduced in part without written approval of Dong Guan Anci Electronic Technology Co., Ltd.

| Table of Contents | Page |
|---|-------------|
| 1 .GENERAL INFORMATION | 5 |
| 1.1 PRODUCT INFORMATION | 5 |
| 1.2 Details about the Test Laboratory | 5 |
| 2. SUMMARY OF TEST RESULTS | 7 |
| 2.1 MEASUREMENT UNCERTAINTY | 8 |
| 2.2 DESCRIPTION OF TEST MODES | 9 |
| 2.3 BLOCK DIGRAM SHOWING THE CONFIGURATION OF SYSTEM TESTED | 10 |
| 3. EMISSION TEST | 11 |
| 3.1 CONDUCTED EMISSION MEASUREMENT | 11 |
| 3.1.1 LIMITS OF CONDUCTED EMISSION(MAINS PORT) | 11 |
| 3.1.2 MEASUREMENT INSTRUMENTS LIST | 11 |
| 3.1.3 TEST PROCEDURE | 12 |
| 3.1.4 DEVIATION FROM TEST STANDARD | 12 |
| 3.1.5 TEST SETUP | 13 |
| 3.1.6 EUT OPERATING CONDITIONS | 13 |
| 3.1.7 TEST RESULTS | 13 |
| 3.2 RADIATED EMISSION MEASUREMENT | 14 |
| 3.2.1 LIMITS OF RADIATED EMISSION MEASUREMENT | 14 |
| 3.2.2 MEASUREMENT INSTRUMENTS LIST | 14 |
| 3.2.3 TEST PROCEDURE | 15 |
| 3.2.4 DEVIATION FROM TEST STANDARD | 15 |
| 3.2.5 TEST SETUP | 16 |
| 3.2.6 EUT OPERATING CONDITIONS | 16 |
| 3.2.7 TEST RESULTS | 17 |
| 4.IMMUNITY TEST | 18 |
| 4.1 STANDARD COMPLIANCE/SERVURITY LEVEL/CRITERIA | 20 |
| 4.2 GENERAL PERFORMANCE CRITERIA | 21 |
| 4.3 GENERAL PERFORMANCE CRITERIA TEST SETUP | 21 |
| 4.4 ESD TESTING | 22 |
| 4.4.1 TEST SPECIFICATION | 22 |
| 4.4.2 MEASUREMENT INSTRUMENTS | 22 |
| 4.4.3 TEST PROCEDURE | 22 |
| 4.4.4 DEVIATION FROM TEST STANDARD | 23 |
| 4.4.5 TEST SETUP | 23 |
| 4.4.6 TEST RESULTS | 24 |

| Table of Contents | Page |
|---|-------------|
| 4.5 RS TESTING2 | 25 |
| 4.5.1 TEST SPECIFICATION | 25 |
| 4.5.2 MEASUREMENT INSTRUMENTS | 25 |
| 4.5.3 TEST PROCEDURE | 25 |
| 4.5.4 DEVIATION FROM TEST STANDARD | 25 |
| 4.5.5 TEST SETUP | 26 |
| 4.5.6 TEST RESULTS | 27 |
| 4.6 EFT/BURST TESTING | 28 |
| 4.6.1 TEST SPECIFICATION | 28 |
| 4.6.2 MEASUREMENT INSTRUMENTS | 28 |
| 4.6.3 TEST PROCEDURE | 28 |
| 4.6.4 DEVIATION FROM TEST STANDARD | 28 |
| 4.6.5 TEST SETUP | 29 |
| 4.6.6 TEST RESULTS | 30 |
| 4.7 SURGE TESTING | 31 |
| 4.7.1 TEST SPECIFICATION | 31 |
| 4.7.2 MEASUREMENT INSTRUMENTS | 31 |
| 4.7.3 TEST PROCEDURE | 31 |
| 4.7.4 DEVIATION FROM TEST STANDARD | 32 |
| 4.7.5 TEST SETUP | 32 |
| 4.7.6 TEST RESULTS | 33 |
| 4.8 INJECTION CURRENT TESTING | 34 |
| 4.8.1 TEST SPECIFICATION | 34 |
| 4.8.2 MEASUREMENT INSTRUMENTS | 34 |
| 4.8.3 TEST PROCEDURE | 34 |
| 4.8.4 DEVIATION FROM TEST STANDARD | 34 |
| 4.8.5 TEST SETUP | 35 |
| 4.8.6 TEST RESULTS | 36 |
| 4.9 VOLTAGE INTERRUPTION/DIPS TESTING | 37 |
| 4.9.1 TEST SPECIFICATION | 37 |
| 4.9.2 MEASUREMENT INSTRUMENTS | 37 |
| 4.9.3 TEST PROCEDURE | 37 |
| 4.9.4 DEVIATION FROM TEST STANDARD | 37 |
| 4.9.5 TEST SETUP | 38 |
| 4.9.6 TEST RESULTS | 38 |
| 4.10 POWER-FREQUENCY MAGNETIC FILDS | 39 |
| 4.10.1 MEASUREMENT INSTRUMENTS | 39 |
| 4.10.2 TEST LEVEL AND PERFORMANCE CRITERION | 39 |
| 4.10.3 TEST PROCEDURE | 39 |



| Table of Contents | | Page |
|--------------------------|------------------------------|-------------|
| 4.10.4 | DEVIATION FROM TEST STANDARD | 39 |
| 4.10.5 | TEST SETUP | 39 |
| 4.10.6 | TEST RESULTS | 40 |
| 5. | ATTACHMENT | 41 |
| 5.1 | EUT TEST PHOTO | 41 |
| 5.2 | EUT PHOTO | 42 |

1 .GENERAL INFORMATION

1.1 PRODUCT INFORMATION

1.The equipment models VT-5301, VT-5302, VT-5321, VT-5322, VT-5331, VT-5334, VT-5341, VT-5342, VT-5352, VT-5361, VT-5362, VT-5552, VT-5332, VT-5333, VT-5542, VT-5543is USB DATA CABLE for the use in information technology equipment.

2.Except for color and appearance, other structural materials are the same.

All tests was performed on model VT-5301.

The EUT passed the test.

1.2 Details about the Test Laboratory

Test Site 1 (CNAS number L6214):

Company name: Dongguan Anci Electronic Technology Co., Ltd.

Address: 1-2 Floor, Building A, No.11, Headquarters 2 Road, Songshan Lake
Hi-tech Industrial Development Zone, Dongguan City,
Guangdong Pr., China.

Telephone: +86-769- 8507 5888

Fax: +86-769- 8507 5898

Test Site 2 (Subcontract test: CNAS number L0468):

Company name: Guangdong Dongguan Quality Supervision Testing Center

Address: No.2 South Industry Road, Dongguan Songshan Lake
Sci.&Tech. Industrial Park, Guangdong Province, China

Telephone: +86 769 2307 1111

Fax: +86 769 2307 7221

| Standard | Test Item | Test Site |
|-------------------------------------|--------------------------------|-----------|
| EN 55032: 2015 | Conducted Emission | N/A |
| | Radiated Emission Below 1 GHz | 1 |
| | Radiated Emission Above 1 GHz | N/A |
| EN 61000-3-2:2014 | Harmonic Current Emission | N/A |
| EN 61000-3-3:2013 | Voltage Fluctuations & Flicker | N/A |
| EN 61000-4-2:2009 | Electrostatic Discharge | 1 |
| EN 61000-4-3:2006 +A1:2008+A2: 2010 | RF electromagnetic field | 2 |
| EN 61000-4-4:2012 | Fast transients | N/A |
| EN 61000-4-5:2014 | Surges | N/A |
| EN 61000-4-6:2014 | Injected Current | N/A |
| EN 61000-4-8:2010 | Power Frequency Magnetic Field | 2 |
| EN 61000-4-11:2004 | Volt. Interruptions Volt. Dips | N/A |

2. SUMMARY OF TEST RESULTS

Test procedures according to the technical standards:

| Emission | | | | |
|--|--------------------------------|------------------------------|----------|----------------------|
| Standard | Test Item | Limit | Judgment | Remark |
| EN 55032: 2015 | Conducted Emission | Class B | N/A | |
| | Radiated Emission Below 1 GHz | Class B | PASS | |
| | Radiated Emission Above 1 GHz | Class B | N/A | NOTE (1) NOTE (4) |
| Immunity (EN 55035: 2017) | | | | |
| Section | Test Item | Performance Criteria | Judgment | Remark |
| EN 61000-4-2:2009 | Electrostatic Discharge | B | PASS | |
| EN 61000-4-3:2006 +A1:2008+A2: 2010 | RF electromagnetic field | A | PASS | |
| EN 61000-4-4:2012 | Fast transients | B | N/A | |
| EN 61000-4-5:2014 | Surges | B | N/A | |
| EN 61000-4-6:2014 | Injected Current | A | N/A | |
| EN 61000-4-8:2010 | Power Frequency Magnetic Field | A | PASS | |
| EN 61000-4-11:2004 | Volt. Interruptions Volt. Dips | B / C / C NOTE (3) | N/A | |

NOTE:

- (1) "N/A" denotes test is not applicable in this Test Report
- (2) The power consumption of EUT is less than 75W and no Limits apply.
- (3) Voltage dip: >95% reduction – Performance Criteria **B**
 Voltage dip: 30% reduction – Performance Criteria **C**
 Voltage Interruption: >95% reduction – Performance Criteria **C**

- (4) If the highest frequency of the internal sources of the EUT is less than 108 MHz, the measurement shall only be made up to 1 GHz. If the highest frequency of the internal sources of the EUT is between 108 MHz and 500 MHz, the measurement shall only be made up to 2GHz. If the highest frequency of the internal sources of the EUT is between 500 MHz and 1GHz, measurement shall only be made up to 5 GHz. If the highest frequency of the internal sources of the EUT is above 1 GHz, the measurement shall be made up to 5 times the highest frequency or 40 GHz, whichever is less.
- (5) Test in the shielding room.

2.1 MEASUREMENT UNCERTAINTY

The reported uncertainty of measurement $y \pm U$, where expanded uncertainty U is based on a standard uncertainty multiplied by a coverage factor of $k=2$, providing a level of confidence of approximately 95 %.

A. Conducted Measurement :

| Test Site | Method | Measurement Frequency Range | U (dB) | NOTE |
|-----------|--------|-----------------------------|--------|------|
| C01 | ANSI | 150 KHz ~ 30MHz | 3.19 | |

B. Radiated Measurement :

| Test Site | Method | Measurement Frequency Range | Ant. H / V | U(dB) | NOTE |
|-----------|--------|-----------------------------|------------|-------|------|
| OS02 | ANSI | 30MHz ~ 200MHz | V | 3.69 | |
| | | 30MHz ~ 200MHz | H | 3.69 | |
| | | 200MHz ~ 1,000MHz | V | 3.67 | |
| | | 200MHz ~ 1,000MHz | H | 3.67 | |

2.2 DESCRIPTION OF TEST MODES

To investigate the maximum EMI emission characteristics generates from EUT, the test system was pre-scanning tested base on the consideration of following EUT operation mode or test configuration mode which possible have effect on EMI emission level. Each of these EUT operation mode(s) or test configuration mode(s) mentioned above was evaluated respectively.

| For Conducted Test | |
|---------------------------|-------------|
| Test Mode | Description |
| Mode 1 | N/A |

| For Radiated Test | |
|--------------------------|------------------|
| Test Mode | Description |
| Mode 1 | Normal Operation |
| Model 2 | |

| For EMS Test | |
|---------------------|------------------|
| Test Mode | Description |
| Model 1 | Normal Operation |

2.3 BLOCK DIGRAM SHOWING THE CONFIGURATION OF SYSTEM TESTED

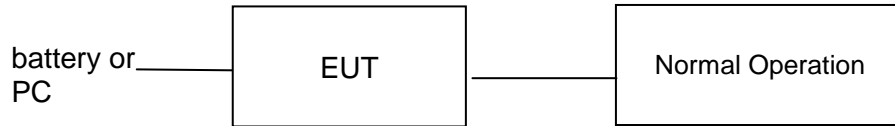

3. EMISSION TEST

3.1 CONDUCTED EMISSION MEASUREMENT

3.1.1 LIMITS OF CONDUCTED EMISSION(MAINS PORT) (Frequency Range 150KHz-30MHz)

| FREQUENCY (MHz) | Class A (dBuV) | | Class B (dBuV) | |
|-----------------|----------------|---------|----------------|-----------|
| | Quasi-peak | Average | Quasi-peak | Average |
| 0.15 -0.5 | 79.00 | 66.00 | 66 - 56 * | 56 - 46 * |
| 0.50 -5.0 | 73.00 | 60.00 | 56.00 | 46.00 |
| 5.0 -30.0 | 73.00 | 60.00 | 60.00 | 50.00 |

Note:

- (1) The tighter limit applies at the band edges.
- (2) The limit of " * " marked band means the limitation decreases linearly with the logarithm of the frequency in the range.
- (3) The test result calculated as following:

Measurement Value = Reading Level + Correct Factor

Correct Factor = Insertion Loss + Cable Loss + Attenuator Factor (if use)

Margin Level = Measurement Value - Limit Value

The following table is the setting of the receiver

| Receiver Parameters | Setting |
|---------------------|----------|
| Attenuation | 10 dB |
| Start Frequency | 0.15 MHz |
| Stop Frequency | 30 MHz |
| IF Bandwidth | 9 kHz |

3.1.2 MEASUREMENT INSTRUMENTS LIST

| Item | Kind of Equipment | Manufacturer | Type No. | Serial No. | Calibrated until |
|------|-------------------|-----------------|-------------|----------------|------------------|
| 1 | LISN | Schwarzbeck | NSLK 8127 | 8127-669 | 2019-05-23 |
| 2 | 10 db attenuator | JFW | 50FP-010-H4 | 43608 46-427-1 | 2019-05-23 |
| 3 | RF Cable | N/A | N/A | 2# | 2019-05-23 |
| 4 | EMI Test Receiver | Rohde & Schwarz | ESCI | 101358 | 2019-05-23 |

Remark: " N/A " denotes No Model No. , Serial No. or No Calibration specified.

3.1.3 TEST PROCEDURE

- a. The EUT was placed 0.4 meters from the horizontal ground plane with EUT being connected to the power mains through a line impedance stabilization network (LISN). All other support equipments powered from additional LISN(s). The LISN provide 50 Ohm/ 50uH of coupling impedance for the measuring instrument.
- b. Interconnecting cables that hang closer than 40 cm to the ground plane shall be folded back and forth in the center forming a bundle 30 to 40 cm long.
- c. I/O cables that are not connected to a peripheral shall be bundled in the center. The end of the cable may be terminated, if required, using the correct terminating impedance. The overall length shall not exceed 1 m.
- d. LISN at least 80 cm from nearest part of EUT chassis.
- e. For the actual test configuration, please refer to the related Item –EUT Test Photos.

3.1.4 DEVIATION FROM TEST STANDARD

No deviation

3.1.5 TEST SETUP

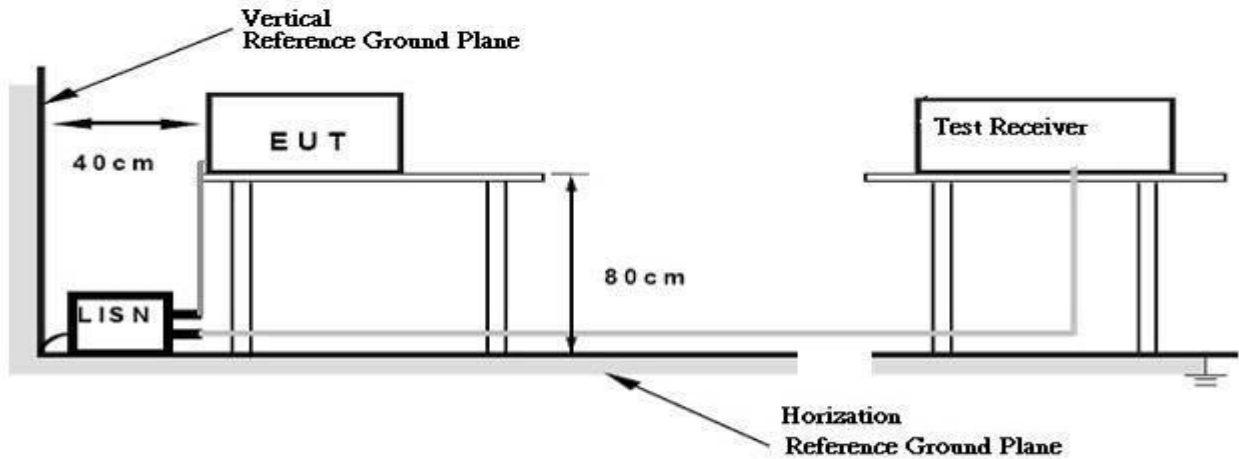

3.1.6 EUT OPERATING CONDITIONS

The EUT exercise program used during radiated and/or conducted emission measurement was designed to exercise the various system components in a manner similar to a typical use.

3.1.7 TEST RESULTS

No applicable the DC product.

3.2 RADIATED EMISSION MEASUREMENT

3.2.1 LIMITS OF RADIATED EMISSION MEASUREMENT (Below 1000MHz)

| FREQUENCY (MHz) | Class A (at 3m) | Class B (at 3m) |
|-----------------|-----------------|-----------------|
| | dBuV/m | dBuV/m |
| 30 – 230 | 50 | 40 |
| 230 – 1000 | 57 | 47 |

Notes:

- (1) The limit for radiated test was performed according to as following:
EN 55032/CISPR 32.
- (2) The tighter limit applies at the band edges.
- (3) Emission level (dBuV/m)=20log Emission level (uV/m).

LIMITS OF RADIATED EMISSION MEASUREMENT (Above 1000MHz)

| FREQUENCY (GHz) | Class A (dBuV/m) (at 3m) | | Class B (dBuV/m) (at 3m) | |
|-----------------|--------------------------|---------|--------------------------|---------|
| | PEAK | AVERAGE | PEAK | AVERAGE |
| 1 ~ 3 | 76 | 56 | 74 | 54 |
| 3 ~ 6 | 80 | 60 | 70 | 50 |

Notes:

- (1) The limit for radiated test was performed according to EN 55032/CISPR 32.
- (2) The tighter limit applies at the band edges.
- (3) Emission level (dBuV/m)=20log Emission level (uV/m).

3.2.2 MEASUREMENT INSTRUMENTS LIST

3m Radiated Emission Measurement 30M-1G

| Item | Kind of Equipment | Manufacturer | Type No. | Serial No. | Calibrated until |
|------|-------------------|-----------------|----------|--------------|------------------|
| 1 | EMI Test Receiver | Rohde & Schwarz | ESPI | 100502 | 2020-01-07 |
| 2 | Pre-Amplifier | HP | 8447D | 2727A06172 | 2020-01-07 |
| 3 | Bilog Antenna | Schwarzbeck | VULB9163 | VULB9163-588 | 2019-05-23 |
| 4 | RF Cable | N/A | N/A | 6# | 2019-05-23 |
| 5 | RF Cable | N/A | N/A | 1-1# | 2019-05-23 |

3m Radiated Emission Measurement 1G-18G

| Item | Kind of Equipment | Manufacturer | Type No. | Serial No. | Calibrated until |
|------|----------------------|--------------|-----------------|--------------------|------------------|
| 1 | Spectrum Analyzer | Agilent | E4407B | US40240623 | 2019-05-23 |
| 2 | Low noise Amplifiers | A-INFO | LA1018N400 9 | J101313052400 1 | 2019-05-23 |
| 3 | Horn antenna | A-INFO | LB-10180-SF | J203109061212 3 | 2019-05-11 |
| 4 | RF Cable | N/A | N/A | 1-2# | 2019-05-23 |
| 5 | RF Cable | N/A | N/A | 7# | 2019-05-23 |

Remark: " N/A" denotes No Model No. / Serial No. and No Calibration specified.

3.2.3 TEST PROCEDURE

- a. The measuring distance of at 3m or 10 m shall be used for measurements at frequency up to 1GHz. For frequencies above 1GHz, any suitable measuring distance may be used.
- b. The EUT was placed on the top of a rotating table 0.8 meters above the ground at a 3m or 10 meter open area test site. The table was rotated 360 degrees to determine the position of the highest radiation.
- c. The height of the equipment or of the substitution antenna shall be 0.8 m; the height of the test antenna shall vary between 1 m to 4 m. Both horizontal and vertical polarizations of the antenna are set to make the measurement.
- d. The initial step in collecting conducted emission data is a spectrum analyzer peak detector mode pre-scanning the measurement frequency range. Significant peaks are then marked and then Quasi Peak detector mode re-measured.
- e. If the Peak Mode measured value compliance with and lower than Quasi Peak Mode Limit, the EUT shall be deemed to meet QP Limits and then no additional QP Mode measurement performed.
- f. For the actual test configuration, please refer to the related Item –EUT Test Photos.

3.2.4 DEVIATION FROM TEST STANDARD

No deviation

3.2.5 TEST SETUP

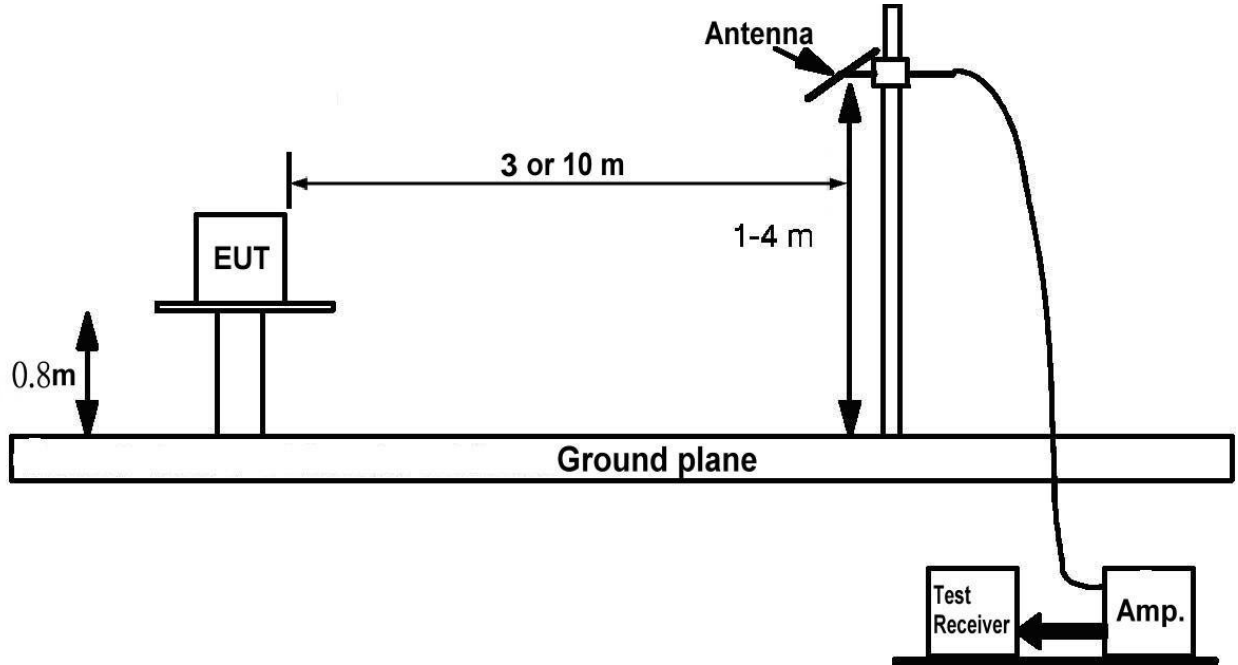

3.2.6 EUT OPERATING CONDITIONS

The EUT tested system was configured as the statements of 3.1.6 Unless otherwise a special operating condition is specified in the follows during the testing.

3.2.7 TEST RESULTS

| | | | |
|---------------------|----------------|---------------------------|---------|
| EUT: | USB DATA CABLE | Model No.: | VT-5301 |
| Temperature: | 26°C | Relative Humidity: | 60 % |
| Pressure: | 1009 hPa | Test Power : | DC 5V |
| Test Mode : | Mode 1 | | |

Remark:

- (1) Reading in which marked as QP or Peak means measurements by using are Quasi-Peak Detector or Peak Detector.
- (2) All readings are Peak unless otherwise stated QP in column of 『Note』 . Peak denotes that the Peak reading compliance with the QP Limits and then QP Mode measurement didn't perform.
- (3) Measuring frequency range from 30MHz to 1000MHz.
- (4) If the peak scan value lower limit more than 20dB, then this signal data does not show in table.

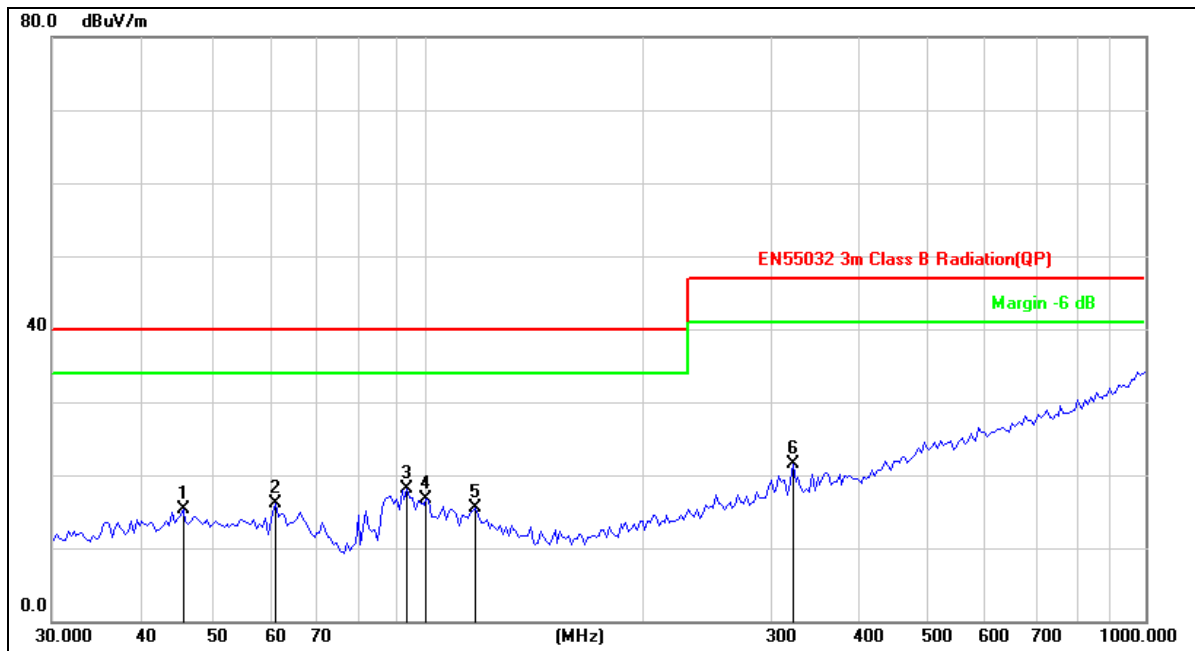

| | | | | | |
|---------------|---|-----------------------|-------------------|------------------------|--------------|
| Site: | LAB | Antenna:: | Vertical | Temperature(C): | 26(C) |
| Limit: | EN55032 3m Class B Radiation(QP) | | | Humidity(%): | 60% |
| EUT: | USB DATA CABLE | Test Time: | 2019/04/12 | | |
| M/N.: | VT-5301 | Power Rating: | DC 5V | | |
| Mode: | Model 1 | Test Engineer: | Dyson | | |
| Note: | | | | | |

| No. | Frequency (MHz) | Reading (dBuV) | Factor (dB/m) | Level (dBuV/m) | Limit (dBuV/m) | Margin (dB) | Det. | Height (cm) | Azimuth (deg) | Remark |
|-----|-----------------|----------------|---------------|----------------|----------------|-------------|------|-------------|---------------|--------|
| 1 | 45.6948 | 27.93 | -12.56 | 15.37 | 40.00 | -24.63 | peak | | | |
| 2 | 61.5618 | 29.56 | -13.52 | 16.04 | 40.00 | -23.96 | peak | | | |
| 3 * | 93.7685 | 31.07 | -12.88 | 18.19 | 40.00 | -21.81 | peak | | | |
| 4 | 99.7028 | 28.14 | -11.41 | 16.73 | 40.00 | -23.27 | peak | | | |
| 5 | 116.7446 | 27.94 | -12.40 | 15.54 | 40.00 | -24.46 | peak | | | |
| 6 | 322.7540 | 29.53 | -8.04 | 21.49 | 47.00 | -25.51 | peak | | | |

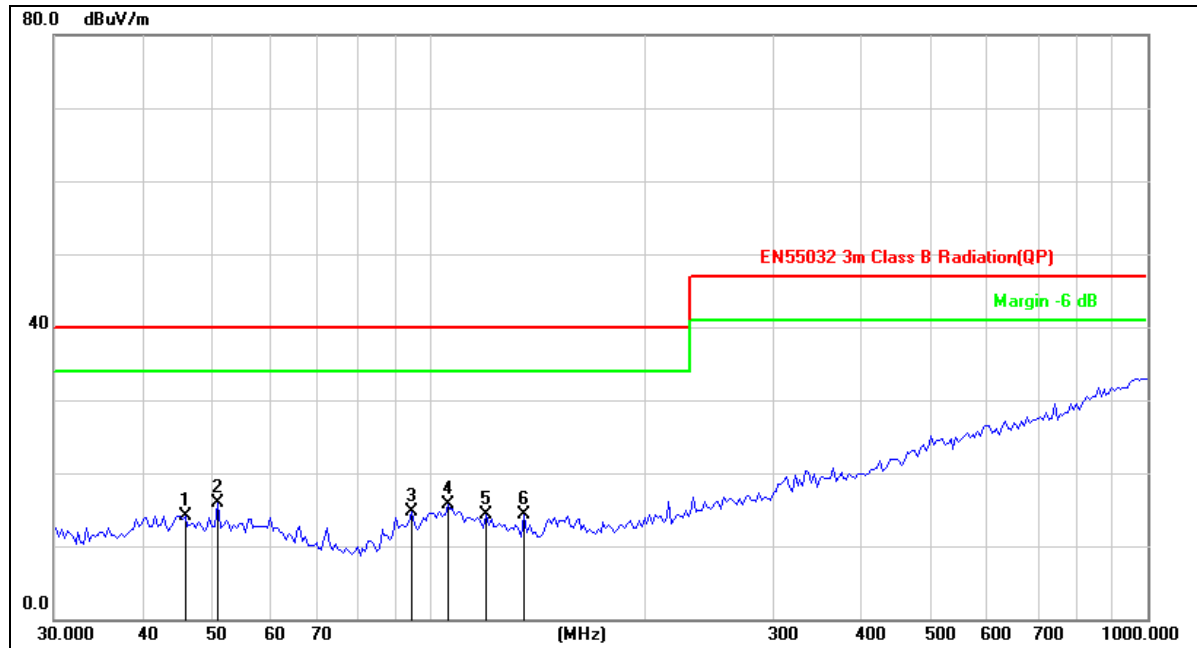

| | | | |
|---------------|---|----------------------------|-----------------------------|
| Site: | LAB | Antenna::Horizontal | Temperature(C):26(C) |
| Limit: | EN55032 3m Class B Radiation(QP) | | Humidity(%):60% |
| EUT: | USB DATA CABLE | Test Time: | 2019/04/12 |
| M/N.: | VT-5301 | Power Rating: | DC 5V |
| Mode: | Model 1 | Test Engineer: | Dyson |
| Note: | | | |

| No. | Frequency (MHz) | Reading (dBuV) | Factor (dB/m) | Level (dBuV/m) | Limit (dBuV/m) | Margin (dB) | Det. | Height (cm) | Azimuth (deg) | Remark |
|-----|-----------------|----------------|---------------|----------------|----------------|-------------|------|-------------|---------------|--------|
| 1 | 45.6948 | 26.74 | -12.56 | 14.18 | 40.00 | -25.82 | peak | | | |
| 2 * | 50.7637 | 28.52 | -12.65 | 15.87 | 40.00 | -24.13 | peak | | | |
| 3 | 94.5941 | 27.35 | -12.71 | 14.64 | 40.00 | -25.36 | peak | | | |
| 4 | 106.0126 | 27.50 | -11.73 | 15.77 | 40.00 | -24.23 | peak | | | |
| 5 | 119.8556 | 26.98 | -12.63 | 14.35 | 40.00 | -25.65 | peak | | | |
| 6 | 135.5062 | 27.96 | -13.66 | 14.30 | 40.00 | -25.70 | peak | | | |

4. IMMUNITY TEST

4.1 STANDARD COMPLIANCE/SERVRITY LEVEL/CRITERIA

| Tests Standard No. | Test Specification | Test Mode Test Ports | Perform. Criteria | Remark |
|---|--|---------------------------------|-----------------------------|--------|
| 1. ESD IEC/EN 61000-4-2 | 8KV air discharge 4KV contact discharge | Direct Mode | B | PASS |
| | 4KV HCP discharge 4KV VCP discharge | Indirect Mode | B | PASS |
| 2. RS IEC/EN 61000-4-3 | 80 MHz to 1000 MHz, 1800, 2600, 3500, 5000 MHz 3V/m(rms), 1 KHz, 80%, AM modulated | Enclosure | A | PASS |
| 3. EFT/Burst IEC/EN 61000-4-4 | 1.0KV(peak) 5/50ns Tr/Th 5KHz Repetition Freq. | AC Power Port | B | N/A |
| | 0.5 KV(peak) 5/50ns Tr/Th 5KHz Repetition Freq. | CTL/Signal Data Line Port | B | N/A |
| 4. Surges IEC/EN 61000-4-5 | 1 KV(5P/5N) 1.2/50(8/20) Tr/Th us | L-N | B | N/A |
| | 2 KV(5P/5N) 1.2/50(8/20) Tr/Th us | L-PE N-PE | B | N/A |
| 5 Injected Current IEC/EN 61000-4-6 | 0.15 MHz to 10 MHz 3V (rms), 10 MHz to 30 MHz 3V ~1V (rms), 30 MHz to 80 MHz 1V(rms), 1KHz 80%, AM Modulated 150Ω source impedance | CTL/Signal Port | A | N/A |
| | | AC Power Port | A | N/A |
| | | DC Power Port | A | N/A |
| 6. Power Frequency Magnetic Field IEC/EN 61000-4-8 | 50Hz or 60Hz, 1A/m | Enclosure | A | PASS |
| 7. Volt. Interruptions Volt. Dips IEC/EN 61000-4-11 | Voltage dip >95% / 30% Interruption >95% | AC Power Port | B / C C See Remark(2) | N/A |

* Remark:

- (1) "N/A": denotes test is not applicable in this Test Report.
- (2) Voltage dip: >95% reduction – Performance Criteria **B**
 Voltage dip: 30% reduction – Performance Criteria **C**
 Voltage Interruption: >95% reduction – Performance Criteria **C**

4.2 GENERAL PERFORMANCE CRITERIA

According to **EN55035: 2017** standard, the general performance criteria as following:

| | |
|--------------------|---|
| Criterion A | The equipment shall continue to operate as intended without operator intervention. No degradation of performance or loss of function is allowed below a performance level specified by the manufacturer when the equipment is used as intended. The performance level may be replaced by a permissible loss of performance. If the minimum performance level or the permissible performance loss is not specified by the manufacturer, then either of these may be derived from the product description and documentation, and by what the user product description and documentation, and by what the user may reasonably expect from the equipment if used as intended. |
| Criterion B | After the test, the equipment shall continue to operate as intended without operator Intervention. No degradation of performance or loss of function is allowed, after the application of the phenomenon below a performance level specified by the manufacturer, when the equipment is used as intended. The performance level may be replaced by a permissible loss of performance. During the test, degradation of performance is allowed. However, no change of operating state if stored data allowed to persist after the test. If the minimum performance level (or the permissible performance loss) is not specified by the manufacturer, then either of these may be derived from the product description and documentation, and by what the user may reasonably expect from the equipment if used as intended. |
| Criterion C | Loss of function is allowed, provided the function is self-recoverable, or can be restored by the operation of the controls by the user in accordance with the manufacturer's instructions. Functions, and/or information stored in non-volatile memory, or protected by a battery backup, shall not be lost. |

4.3 GENERAL PERFORMANCE CRITERIA TEST SETUP

The EUT tested system was configured as the statements of **3.1.6** Unless otherwise a special operating condition is specified in the follows during the testing.

4.4 ESD TESTING

4.4.1 TEST SPECIFICATION

| | |
|-----------------------------|---|
| Basic Standard: | IEC/EN 61000-4-2 |
| Discharge Impedance: | 330 ohm / 150 pF |
| Required Performance | B |
| Discharge Voltage: | Air Discharge: 2kV/4kV/8kV (Direct) Contact Discharge: 2kV/4kV (Direct/Indirect) |
| Polarity: | Positive & Negative |
| Number of Discharge: | Air Discharge: min. 20 times at each test point Contact Discharge: min. 200 times in total |
| Discharge Mode: | Contact and Air |
| Discharge Period: | 1 second minimum |

4.4.2 MEASUREMENT INSTRUMENTS

| Item | Kind of Equipment | Manufacturer | Type No. | Serial No. | Calibrated until |
|------|-------------------|--------------|-----------|------------|------------------|
| 1 | ESD Simulator | Prima | ESD61002B | PR13012530 | 2019-05-11 |

Remark: " N/A " denotes No Model No. / Serial No. and No Calibration specified.

4.4.3 TEST PROCEDURE

The test generator necessary to perform direct and indirect application of discharges to the EUT in the following manner:

- a. Contact discharge was applied to conductive surfaces and coupling planes of the EUT.

During the test, it was performed with single discharges. For the single discharge time between successive single discharges was at least 1 second. The EUT shall be exposed to at least 200 discharges, 100 each at negative and positive polarity, at a minimum of four test points. One of the test points shall be subjected to at least 50 indirect discharges to the center of the front edge of the horizontal coupling plane. The remaining three test points shall each receive at least 50 direct contact discharges.

If no direct contact test points are available, then at least 200 indirect discharges shall be applied in the indirect mode. Test shall be performed at a maximum repetition rate of one discharge per second.

Vertical Coupling Plane (VCP):
The coupling plane, of dimensions 0.5m x 0.5m, is placed parallel to, and positioned at a distance 0.1m from, the EUT, with the Discharge Electrode touching the coupling plane.
The four faces of the EUT will be performed with electrostatic discharge.

Horizontal Coupling Plane (HCP):
The coupling plane is placed under to the EUT. The generator shall be positioned vertically at a distance of 0.1m from the EUT, with the Discharge Electrode touching the coupling plane.
The four faces of the EUT will be performed with electrostatic discharge.
- b. Air discharges at insulation surfaces of the EUT.

It was at least ten single discharges with positive and negative at the same selected point.
- c. For the actual test configuration, please refer to the related Item –EUT Test Photos.

4.4.4 DEVIATION FROM TEST STANDARD

No deviation

4.4.5 TEST SETUP

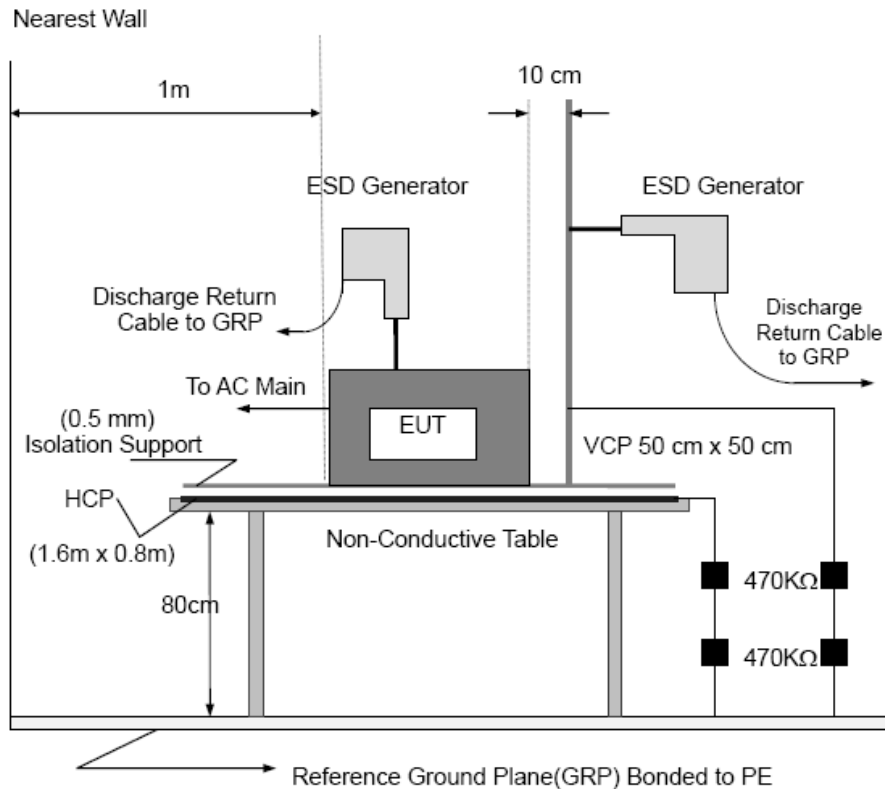

Note:

TABLE-TOP EQUIPMENT

The configuration consisted of a wooden table 0.8 meters high standing on the Ground Reference Plane. The GRP consisted of a sheet of aluminum at least 0.25mm thick, and 2.5 meters square connected to the protective grounding system. A Horizontal Coupling Plane (1.6m x 0.8m) was placed on the table and attached to the GRP by means of a cable with 940k total impedance. The equipment under test, was installed in a representative system as described in section 7 of IEC /EN 61000-4-2, and its cables were placed on the HCP and isolated by an insulating support of 0.5mm thickness. A distance of 1-meter minimum was provided between the EUT and the walls of the laboratory and any other metallic structure.

FLOOR-STANDING EQUIPMENT

The equipment under test was installed in a representative system as described in section 7 of IEC/EN 61000-4-2, and its cables were isolated from the Ground Reference Plane by an insulating support of 0.1-meter thickness. The GRP consisted of a sheet of aluminum that is at least 0.25mm thick, and 2.5meters square connected to the protective grounding system and extended at least 0.5 meters from the EUT on all sides.

4.4.6 TEST RESULTS

| Mode | Air Discharge | | | | | | | | Contact Discharge | | | | | | | |
|----------|---------------|----|-----|----|-----|----|------|----|-------------------|----|-----|----|-----|----|-----|----|
| | 2KV | | 4KV | | 8KV | | 12KV | | 2KV | | 4KV | | 6KV | | 8KV | |
| Location | P | N | P | N | P | N | P | N | P | N | P | N | P | N | P | N |
| 1 | -- | -- | B | B | B | B | -- | -- | -- | -- | -- | -- | -- | -- | -- | -- |
| 2 | -- | -- | -- | -- | -- | -- | -- | -- | B | B | B | A | -- | -- | -- | -- |
| 3 | - | -- | -- | -- | -- | -- | -- | -- | -- | -- | -- | -- | -- | -- | -- | -- |
| 4 | -- | -- | -- | -- | -- | -- | -- | -- | -- | -- | -- | -- | -- | -- | -- | -- |
| 5 | -- | -- | -- | -- | -- | -- | -- | -- | -- | -- | -- | -- | -- | -- | -- | -- |
| 6 | - | -- | -- | -- | -- | -- | -- | -- | -- | -- | -- | -- | -- | -- | -- | -- |
| 7 | -- | -- | -- | -- | -- | -- | -- | -- | -- | -- | -- | -- | -- | -- | -- | -- |
| 8 | -- | -- | -- | -- | - | -- | -- | -- | -- | -- | -- | -- | -- | -- | -- | -- |
| 9 | -- | -- | -- | -- | - | -- | -- | -- | -- | -- | -- | -- | -- | -- | -- | -- |
| Criteria | B | | | | | | | | B | | | | | | | |
| Result | B | | | | | | | | B | | | | | | | |
| Judgment | PASS | | | | | | | | PASS | | | | | | | |

| Mode | HCP Discharge | | | | | | | | VCP Discharge | | | | | | | |
|----------|---------------|----|-----|---|-----|----|-----|----|---------------|----|-----|---|-----|----|-----|----|
| | 2KV | | 4KV | | 6KV | | 8KV | | 2KV | | 4KV | | 6KV | | 8KV | |
| Location | P | N | P | N | P | N | P | N | P | N | P | N | P | N | P | N |
| 1 | -- | -- | A | A | -- | -- | -- | -- | - | -- | A | A | -- | -- | -- | -- |
| 2 | -- | -- | A | A | -- | -- | -- | -- | -- | -- | A | A | -- | -- | -- | -- |
| 3 | -- | -- | A | A | - | -- | -- | -- | -- | -- | A | A | - | -- | -- | -- |
| 4 | - | -- | A | A | -- | -- | -- | -- | - | -- | A | A | -- | -- | -- | -- |
| Criteria | B | | | | | | | | B | | | | | | | |
| Result | A | | | | | | | | A | | | | | | | |
| Judgment | PASS | | | | | | | | PASS | | | | | | | |

Note:

- 1) P/N denotes the Positive/Negative polarity of the output voltage.
- 2) Test condition:
 Direct discharges: Minimum 50 times (Positive/Negative) at each point. Air discharges / Indirect (HCP/VCP): Minimum 20 times (Positive/Negative) at each point.
- 3) Test location(s) in which discharge (Air and contact discharge) to be described as following
- 4) The Indirect (HCP/VCP) discharges description of test point as following:
 1.left side 2.right side 3.front side 4.rear side
- 5) N/A - denotes test is not applicable in this test report
- 7) Criteria B: The EUT function loss during the test, but self-recoverable after the test.

Test location description:

| No | Description | No | Description |
|----|--------------------------------------|----|-------------|
| 1 | Metal 4points | 4 | |
| 2 | Output port 2points | 5 | |
| 3 | | 6 | |

4.5 RS TESTING2

4.5.1 TEST SPECIFICATION

| | |
|-----------------------------|---|
| Basic Standard: | IEC/EN 61000-4-3 |
| Required Performance | A |
| Frequency Range: | 80 MHz - 1000 MHz, 1800, 2600, 3500, 5000 MHz |
| Field Strength: | 3 V/m |
| Modulation: | 1kHz Sine Wave, 80%, AM Modulation |
| Frequency Step: | 1 % of fundamental |
| Polarity of Antenna: | Horizontal and Vertical |
| Test Distance: | 3 m |
| Antenna Height: | 1.5 m |
| Dwell Time: | at least 3 seconds |

4.5.2 MEASUREMENT INSTRUMENTS

| Item | Kind of Equipment | Manufacturer | Type No. | Serial No. | Calibrated until |
|------|--------------------------------|--------------|-------------|------------|------------------|
| 1 | Signal Generator | Agillet | N517113-50B | MY53050160 | 2019-10-21 |
| 2 | Amplifier | A&R | 150W1000M3 | 313157 | 2019-10-18 |
| 3 | Amplifier | A&R | 50SIG6M2 | 0342835 | 2019-11-07 |
| 4 | Log-periodic Antenna | SCHWARZBECK | STLP 9128E | 9128E-012 | 2020-01-19 |
| 5 | Microwave log-periodic antenna | SCHWARZBECK | STLP 9149 | 9149.222 | 2019-12-13 |
| 6 | Isotropic Field Probe | A&R | FL700 | 0342652 | 2019-09-11 |
| 7 | 10 meter anechoic chamber | Albatross | 10m | / | 2020-06-26 |

Remark: " N/A" denotes No Model No. / Serial No. and No Calibration specified.

4.5.3 TEST PROCEDURE

The EUT and support equipment, which are placed on a table that is 0.8 meter above ground and the testing was performed in a fully-anechoic chamber.

The testing distance from antenna to the EUT was 3 meters.

The other condition as following manner:

- a. The field strength level was 3V/m.
- b. The frequency range is swept from 80 MHz to 1000 MHz and 1800 MHz, 2600 MHz, 3500 MHz, 5000 MHz, with the signal 80%amplitude modulated with a 1kHz sine wave. The rate of sweep did not exceed 1.5×10^{-3} decade/s. Where the frequency range is swept incrementally, the step size was 1% of fundamental.
- c. The dwell time at each frequency shall be not less than the time necessary for the EUT to be able to respond.
- d. The test was performed with the EUT exposed to both vertically and horizontally polarized fields on each of the four sides.
- e. For the actual test configuration, please refer to the related Item –EUT Test Photos.

4.5.4 DEVIATION FROM TEST STANDARD

No deviation

4.5.5 TEST SETUP

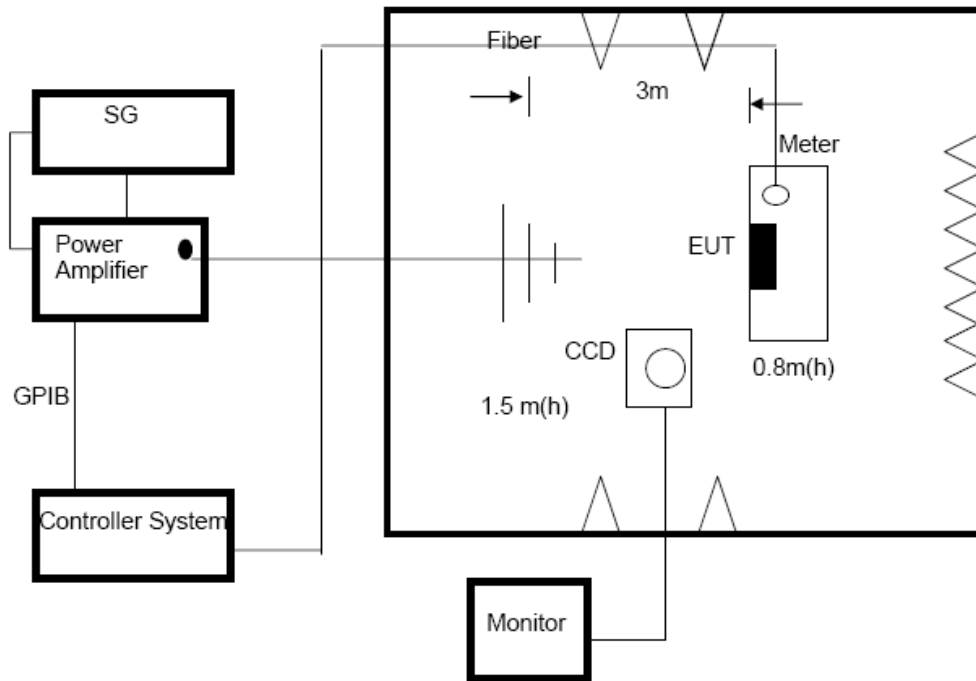

Note:

TABLE-TOP EQUIPMENT

The EUT installed in a representative system as described in section 7 of IEC/EN 61000-4-3 was placed on a non-conductive table 0.8 meters in height. The system under test was connected to the power and signal wire according to relevant installation instructions.

FLOOR-STANDING EQUIPMENT

The EUT installed in a representative system as described in section 7 of IEC/EN 61000-4-3 was placed on a non-conductive wood support 0.1 meters in height. The system under test was connected to the power and signal wire according to relevant installation instructions.

4.5.6 TEST RESULTS

| Frequency Range (MHz) | Polarity of Antenna | R.F. Field Strength | Azimuth | Perform. Criteria | Results | Judgment |
|-----------------------|---------------------|--|---------|-------------------|----------|-------------|
| 80MHz - 1000MHz | H / V | 3 V/m (rms) AM Modulated 1000Hz, 80% | Front | A | A | PASS |
| | | | Rear | | | |
| | | | Left | | | |
| | | | Right | | | |

| Frequency Range (MHz) | Polarity of Antenna | R.F. Field Strength | Azimuth | Perform. Criteria | Results | Judgment |
|-------------------------------|---------------------|--|---------|-------------------|----------|-------------|
| 1800, 2600, 3500, 5000 MHz | H / V | 3 V/m (rms) AM Modulated 1000Hz, 80% | Front | A | A | PASS |
| | | | Rear | | | |
| | | | Left | | | |
| | | | Right | | | |

Note:

- 1) H/V denotes the Horizontal/Vertical polarity of Antenna.
- 2) N/A - denotes test is not applicable in this test report.
- 3) Criteria A: There was no change operated with initial operating during the test.
- 4) Criteria B: The EUT function loss during the test, but self-recoverable after the test.
- 5) Criteria C: The system shut down during the test.

4.6 EFT/BURST TESTING

4.6.1 TEST SPECIFICATION

| | |
|-----------------------------|------------------------|
| Basic Standard: | IEC/EN 61000-4-4 |
| Required Performance | B |
| Test Voltage: | Power Line: ± 1 kV |
| Polarity: | Positive & Negative |
| Impulse Frequency: | 5 kHz |
| Impulse Wave shape : | 5/50 ns |
| Burst Duration: | 15 ms |
| Burst Period: | 300 ms |
| Test Duration: | Not less than 1 min. |

4.6.2 MEASUREMENT INSTRUMENTS

| Item | Kind of Equipment | Manufacturer | Type No. | Serial No. | Calibrated until |
|------|--|--------------|-------------|----------------------|------------------|
| 1 | Electrical Intelligent Transient Generator | Everfine | EMS61000-4B | G114921CA134 1115 | 2019-05-23 |

Remark: " N/A" denotes No Model No. / Serial No. and No Calibration specified.

4.6.3 TEST PROCEDURE

The EUT and support equipment, are placed on a table that is 0.8 meter above a metal ground plane measured 1m*1m min. and 0.65mm thick min.

The other condition as following manner:

- a. The length of power cord between the coupling device and the EUT should not exceed 1 meter.
- b. Both positive and negative polarity discharges were applied.
- c. The duration time of each test sequential was 1 minute
- d. For the actual test configuration, please refer to the related Item –EUT Test Photos.

4.6.4 DEVIATION FROM TEST STANDARD

No deviation

4.6.5 TEST SETUP

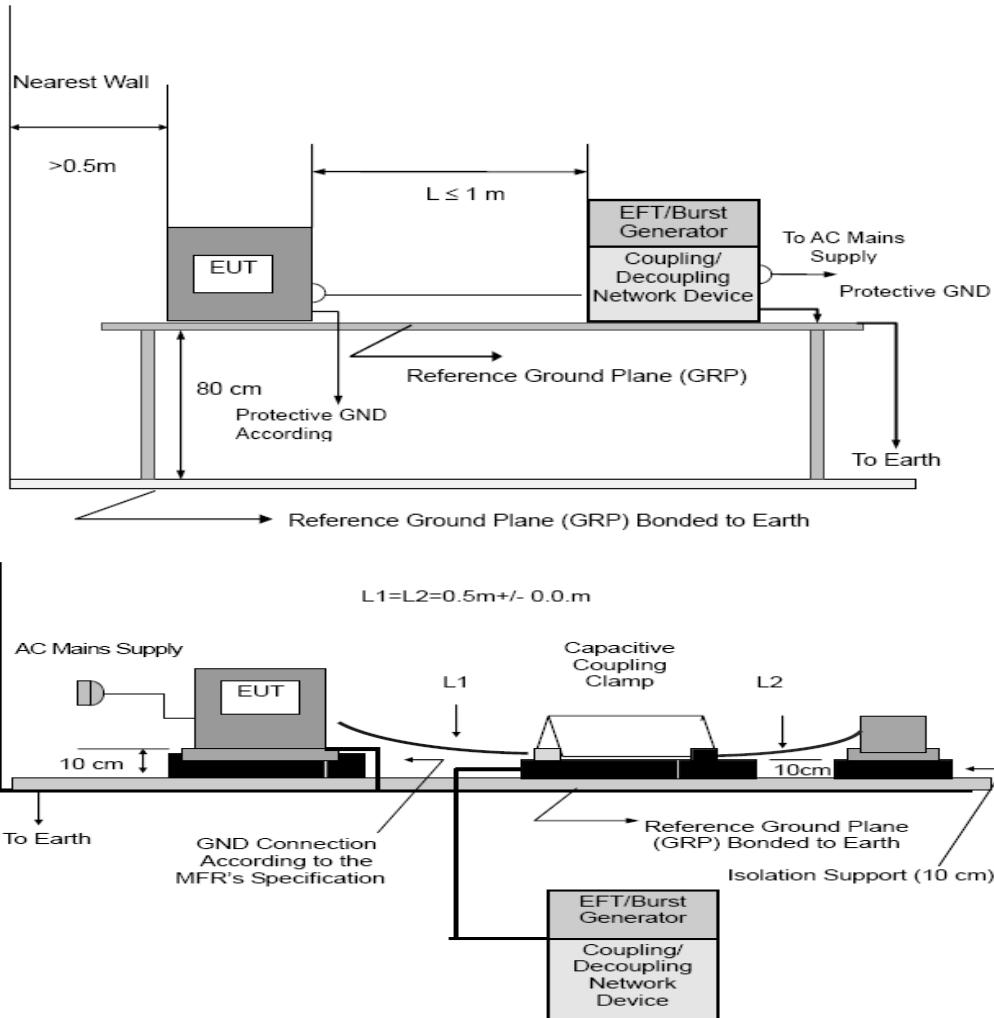

Note:

TABLE-TOP EQUIPMENT

The configuration consisted of a wooden table (0.8m high) standing on the Ground Reference Plane. The GRP consisted of a sheet of aluminum (at least 0.25mm thick and 2.5m square) connected to the protective grounding system. A minimum distance of 0.5m was provided between the EUT and the walls of the laboratory or any other metallic structure.

FLOOR-STANDING EQUIPMENT

The EUT installed in a representative system as described in section 7 of IEC/EN 61000-4-4 and its cables, were isolated from the Ground Reference Plane by an insulating support that is 0.1-meter thick. The GRP consisted of a sheet of aluminum (at least 0.25mm thick and 2.5m square) connected to the protective grounding system.

4.6.6 TEST RESULTS

| Mode | AC Power Line | | DC Power Line | | Signal/Control Line | |
|---------------------|---------------|---------|---------------|---------|---------------------|---------|
| Test Level | 1KV | | 0.5KV | | 0.5KV | |
| Port(s) | Polarity | Results | Polarity | Results | Polarity | Results |
| Line (L) | P | | P | | P | |
| | N | | N | | N | |
| Neutral (N) | P | | P | | P | |
| | N | | N | | N | |
| Ground (PE) | P | | P | | P | |
| | N | | N | | N | |
| Signal/Control Line | P | | P | | P | |
| | N | | N | | N | |
| Criteria | B | | B | | B | |
| Result | -- | | -- | | -- | |
| Judgment | N/A | | N/A | | N/A | |

- 1) P/N denotes the Positive/Negative polarity of the output voltage.
- 2) N/A - denotes test is not applicable in this test report
- 3) Criteria A: There was no change operated with initial operating during the test.
- 4) Criteria B: The EUT function loss during the test, but self-recoverable after the test.
- 5) Criteria C: The system shut down during the test.

4.7 SURGE TESTING

4.7.1 TEST SPECIFICATION

| | |
|-------------------------------|--|
| Basic Standard: | IEC/EN 61000-4-5 |
| Required Performance | B |
| Wave-Shape: | Combination Wave 1.2/50 us Open Circuit Voltage 8 /20 us Short Circuit Current |
| Test Voltage: | Power Line: 0.5 kV, 1 kV, 2 kV |
| Surge Input/Output: | L-N, L-PE, N-PE |
| Generator Source: | 2 ohm between networks |
| Impedance: | 12 ohm between network and ground |
| Polarity: | Positive/Negative |
| Phase Angle: | 0 /90/180/270 |
| Pulse Repetition Rate: | 1 time / min. (maximum) |
| Number of Tests: | 5 positive and 5 negative at selected points |

4.7.2 MEASUREMENT INSTRUMENTS

| Item | Kind of Equipment | Manufacturer | Type No. | Serial No. | Calibrated until |
|------|---------------------------|--------------|------------|------------|------------------|
| 1 | Lightning surge generator | Prima | SUG61005CX | PR13065597 | 2019-05-23 |

Remark: " N/A" denotes No Model No. / Serial No. and No Calibration specified.

4.7.3 TEST PROCEDURE

a. For EUT SWITCHING AC/DC ADAPTOR:

The surge is to be applied to the EUT SWITCHING AC/DC ADAPTOR terminals via the capacitive coupling network. Decoupling networks are required in order to avoid possible adverse effects on equipment not under test that may be powered by the same lines, and to provide sufficient decoupling impedance to the surge wave. The power cord between the EUT and the coupling/decoupling networks shall be 2meters in length (or shorter).

b. For test applied to unshielded unsymmetrically operated interconnection lines of EUT:

The surge is applied to the lines via the capacitive coupling. The coupling /decoupling networks shall not influence the specified functional conditions of the EUT. The interconnection line between the EUT and the coupling/decoupling networks shall be 2 meters in length (or shorter).

c. For test applied to unshielded symmetrically operated interconnection /telecommunication lines of EUT:

The surge is applied to the lines via gas arrestors coupling. Test levels below the ignition point of the coupling arrestor cannot be specified. The interconnection line between the EUT and the coupling/decoupling networks shall be 2 meters in length (or shorter).

d. For the actual test configuration, please refer to the related Item –EUT Test Photos.

4.7.4 DEVIATION FROM TEST STANDARD

No deviation

4.7.5 TEST SETUP

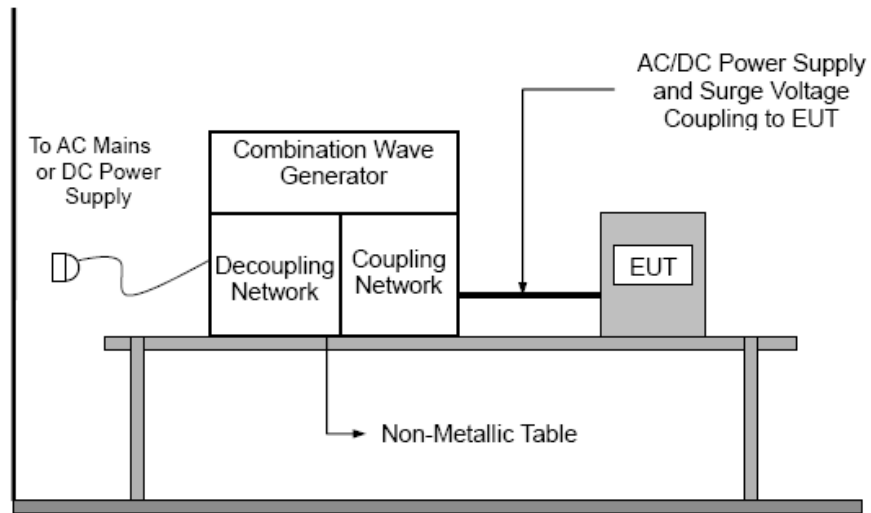

4.7.6 TEST RESULTS

| Wave Form EUT Ports Tested | 1.2/50(8/20) us | | | | | | Criteria | Judgment |
|-------------------------------|-----------------|-------|---------|-----|-------|-----|----------|----------|
| | Polarity | Phase | Voltage | | | | | |
| | | | 0.5kV | 1kV | 1.5kV | 2kV | | |
| L - N | +/- | 0° | | | | | N/A | N/A |
| | +/- | 90° | | | | | | |
| | +/- | 180° | | | | | | |
| | +/- | 270° | | | | | | |
| L - PE | +/- | 0° | | | | | N/A | N/A |
| | +/- | 90° | | | | | | |
| | +/- | 180° | | | | | | |
| | +/- | 270° | | | | | | |
| N - PE | +/- | 0° | | | | | N/A | N/A |
| | +/- | 90° | | | | | | |
| | +/- | 180° | | | | | | |
| | +/- | 270° | | | | | | |
| Signal Line (N/A) | +/- | 0° | | | | | N/A | N/A |
| | +/- | 90° | | | | | | |
| | +/- | 180° | | | | | | |
| | +/- | 270° | | | | | | |
| Signal Line (N/A) | +/- | 0° | | | | | N/A | N/A |
| | +/- | 90° | | | | | | |
| | +/- | 180° | | | | | | |
| | +/- | 270° | | | | | | |

Note:

1) N/A - denotes test is not applicable in this Test Report

4.8 INJECTION CURRENT TESTING

4.8.1 TEST SPECIFICATION

| | |
|-----------------------------|--|
| Basic Standard: | IEC/EN 61000-4-6 |
| Required Performance | A |
| Frequency Range: | 3V (rms), 0.15MHz ~ 10MHz; 3V ~1V (rms), 10MHz ~ 30MHz; 1V (rms), 30MHz ~ 80MHz; |
| Field Strength: | 3V (rms), 3V ~1V (rms), 1V (rms) |
| Modulation: | 1kHz Sine Wave, 80%, AM Modulation |
| Frequency Step: | 1 % of fundamental |
| Dwell Time: | at least 3 seconds |

4.8.2 MEASUREMENT INSTRUMENTS

| Item | Kind of Equipment | Manufacturer | Type No. | Serial No. | Calibrated until |
|------|--------------------------------|--------------|-----------|------------|------------------|
| 1 | CONDUCTED IMMUNITY TEST SYSTEM | FRANKONIA | CIT-10 | 102D1253 | 2019-10-08 |
| 2 | CDN | FRANKONIA | CDN M2+M3 | A3011059 | 2019-10-08 |
| 3 | Electromagnetic clamp | FRANKONIA | KEMZ-801 | 21044 | 2019-10-08 |

Remark: " N/A" denotes No Model No. / Serial No. and No Calibration specified.

4.8.3 TEST PROCEDURE

The EUT and support equipment, are placed on a table that is 0.8 meter above a metal ground plane measured 1m*1m min. and 0.65mm thick min.

The other condition as following manner:

- a. The field strength level was 3V (rms), 3V ~1V (rms), 1V (rms).
- b. The frequency range is swept from 150 KHz to 80 MHz, with the signal 80%amplitude modulated with a 1kHz sine wave. The rate of sweep did not exceed 1.5x 10⁻³ decade/s. Where the frequency range is swept incrementally, the step size was 1% of fundamental.
- c. The dwell time at each frequency shall be not less than the time necessary for the EUT to be able to respond.
- d. For the actual test configuration, please refer to the related Item –EUT Test Photos.

4.8.4 DEVIATION FROM TEST STANDARD

No deviation

4.8.5 TEST SETUP

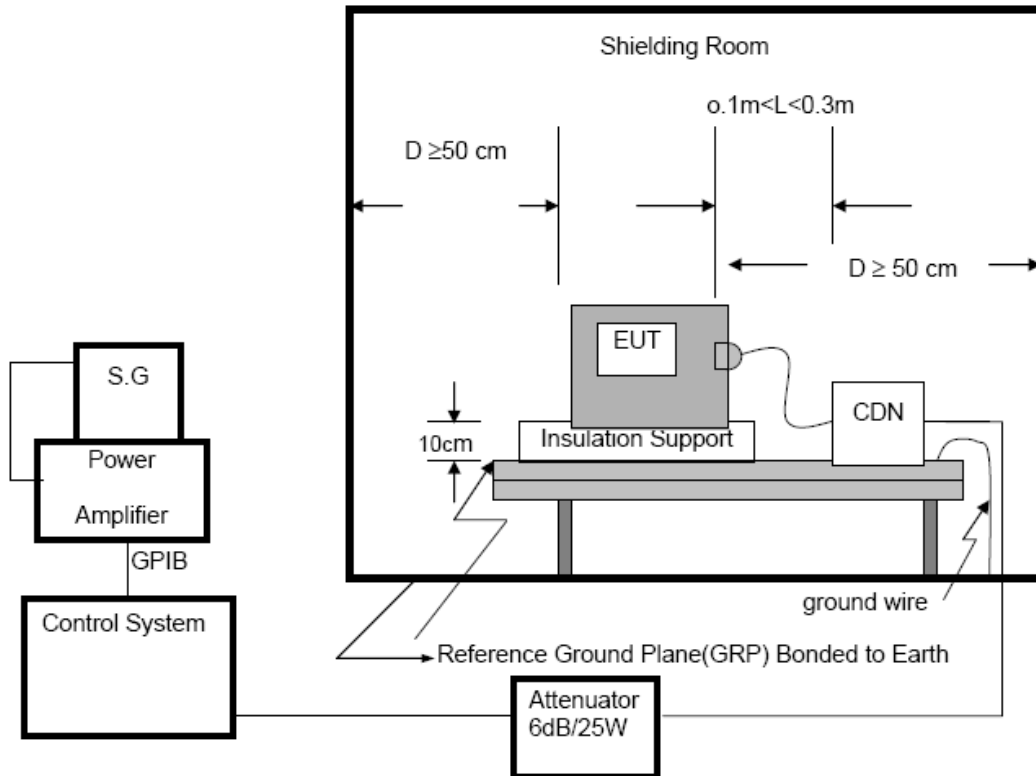

For the actual test configuration, please refer to the related Item –EUT Test Photos.

NOTE:

FLOOR-STANDING EQUIPMENT

The equipment to be tested is placed on an insulating support of 0.1 meters height above a ground reference plane. All relevant cables shall be provided with the appropriate coupling and decoupling devices at a distance between 0.1 meters and 0.3 meters from the projected geometry of the EUT on the ground reference plane.

4.8.6 TEST RESULTS

| Test Ports (Mode) | Freq. Range MHz) | Field Strength | Perform. Criteria | Results | Judgment |
|---------------------------------|---------------------|--|----------------------|---------|------------|
| Input/ Output AC. Power Port | 0.15 ---80 | 3V(rms) AM Modulated 1000Hz, 80% | A | -- | N/A |
| Input/ Output DC. Power Port | 0.15 --- 80 | | A | -- | N/A |
| Signal Line (N/A) | 0.15 --- 80 | | A | -- | N/A |
| Signal Line (N/A) | 0.15 --- 80 | | A | -- | N/A |

Note:

- 1) N/A - denotes test is not applicable in this Test Report.

4.9 VOLTAGE INTERRUPTION/DIPS TESTING

4.9.1 TEST SPECIFICATION

| | |
|--------------------------------|---|
| Basic Standard: | IEC/EN 61000-4-11 |
| Required Performance: | B (For >95% Voltage Dips) C (For 30% Voltage Dips) C (For >95% Voltage Interruptions) |
| Test Duration Time: | Minimum three test events in sequence |
| Interval between Event: | Minimum ten seconds |
| Phase Angle: | 0° |
| Test Cycle: | 3 times |

4.9.2 MEASUREMENT INSTRUMENTS

| Item | Kind of Equipment | Manufacturer | Type No. | Serial No. | Calibrated until |
|------|--|--------------|------------------|----------------------|------------------|
| 1 | Voltage Dips And Interruptions Generator | Everfine | EMS61000-11 K | G113317CA834 1117 | 2019-05-23 |

Remark: " N/A" denotes No Model No. / Serial No. and No Calibration specified.

4.9.3 TEST PROCEDURE

The EUT shall be tested for each selected combination of test levels and duration with a sequence of three dips/interruptions with intervals of 10 s minimum (between each test event). Each representative mode of operation shall be tested. Abrupt changes in supply voltage shall occur at zero crossings of the voltage waveform.

4.9.4 DEVIATION FROM TEST STANDARD

No deviation

4.9.5 TEST SETUP

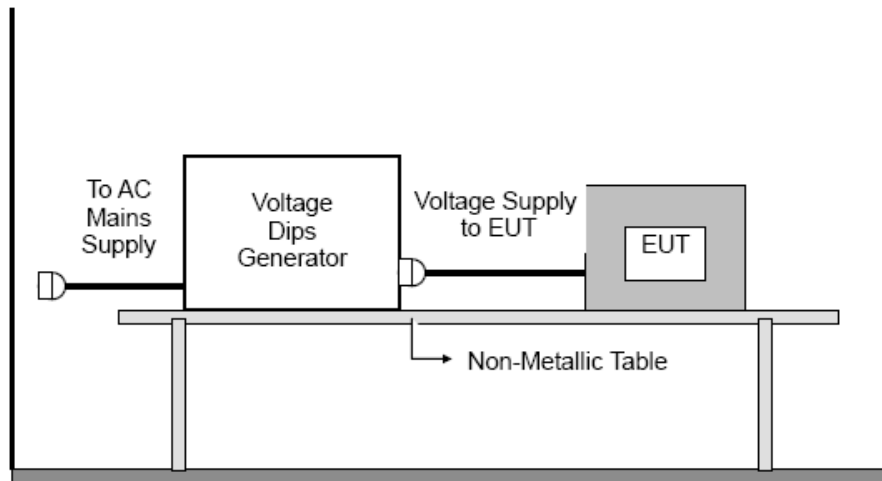

For the actual test configuration, please refer to the related Item –EUT Test Photos.

4.9.6 TEST RESULTS

| Voltage Reduction | Periods | Perform Criteria | Results | Judgment |
|-------------------|---------|------------------|---------|------------|
| Voltage dip >95% | 0.5 | B | -- | N/A |
| Voltage dip 30% | 25 | C | -- | N/A |
| Interruption >95% | 250 | C | -- | N/A |

Note:

- 1) N/A - denotes test is not applicable in this test report.

4.10 POWER-FREQUENCY MAGNETIC FILDS

4.10.1 MEASUREMENT INSTRUMENTS

| Item | Kind of Equipment | Manufacturer | Type No. | Serial No. | Calibrated until |
|------|-----------------------|--------------|----------|------------|------------------|
| 1 | Magnetic Field Tester | EMC-PARTNER | MF1000-1 | 121 | 2019-10-08 |

Remark: " N/A" denotes No Model No. / Serial No. and No Calibration specified.

4.10.2 TEST LEVEL AND PERFORMANCE CRITERION

| Level | Magnetic Field Strength A/m | Performance criterion |
|-------|-----------------------------|-----------------------|
| 1 | 1 | A |

Performance criteria A description: During and after the test the EUT shall continue to operate as intended without operator intervention. No degradation of performance or loss of function is allowed below a minimum performance level specified by the manufacturer when the EUT is used as intended

4.10.3 TEST PROCEDURE

The EUT shall be subjected to the test magnetic field by using the induction coil of standard dimensions (1m*1m) and shown in Section 13.3 The induction coil shall then be rotated by 90 ein order to expose the EUT to the test field with different orientations. .

4.10.4 DEVIATION FROM TEST STANDARD

No deviation

4.10.5 TEST SETUP

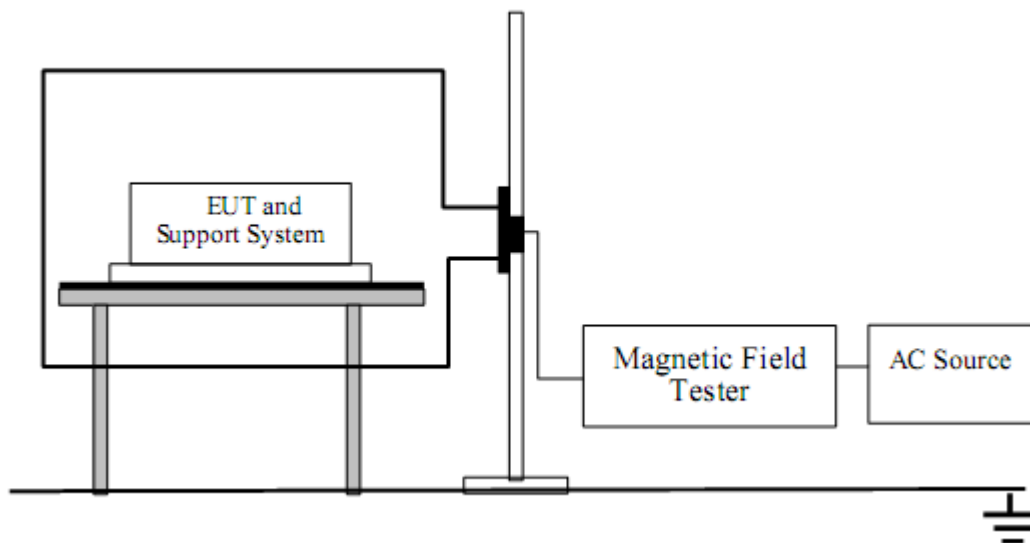

4.10.6 TEST RESULTS

| Operation Mode | Test Level | Testing Duration | Coil Orientation | Required | Observation | Result (Pass/Fail) |
|----------------|------------|------------------|------------------|----------|-------------|--------------------|
| Full Load | 1A/m | 5 min / coil | X | A | A | Pass |
| | 1A/m | 5 min / coil | Y | A | A | Pass |
| | 1A/m | 5 min / coil | Z | A | A | Pass |

Note:

Operation as intend, no loss of function during test and after test

5. ATTACHMENT
5.1 EUT TEST PHOTO

Radiated Measurement Photo



ESD Measurement Photos



5.2 EUT PHOTO

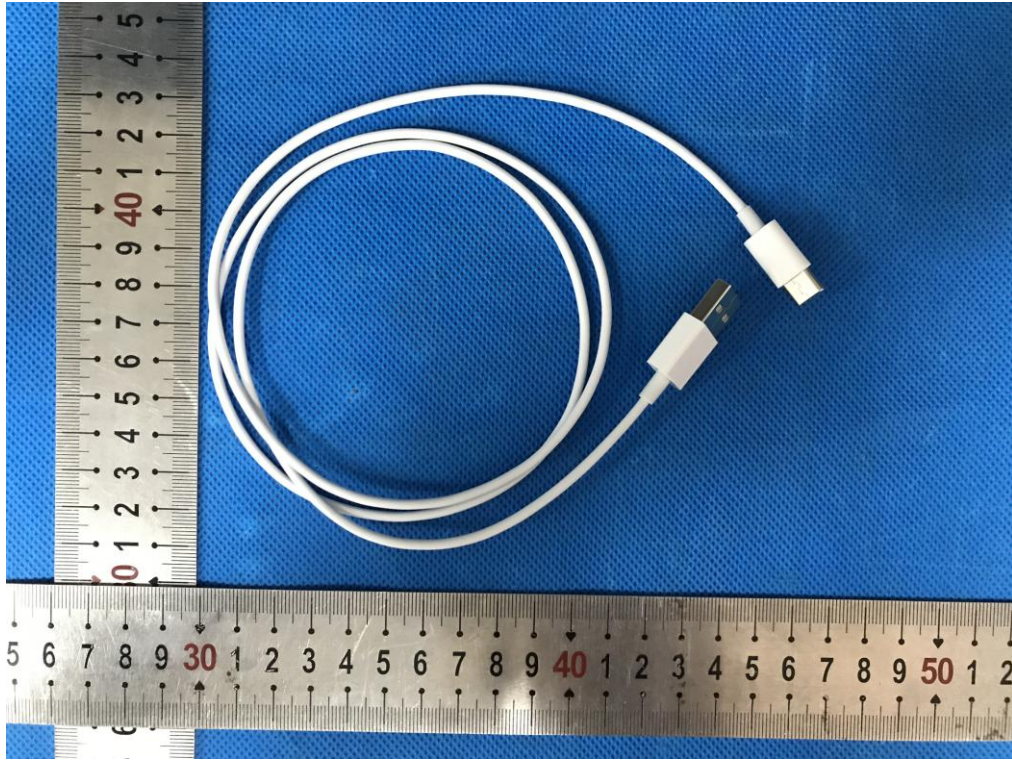

Figure 1. Overall view of unit (VT-5322)

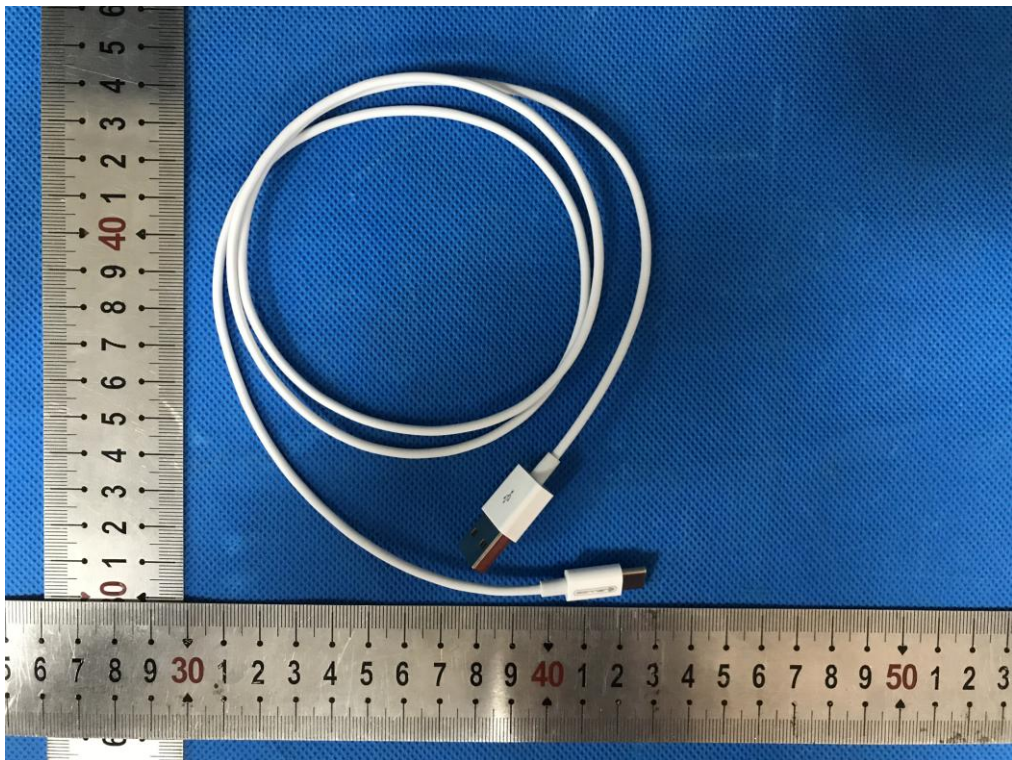

Figure 2. Overall view of unit (VT-5322)



Figure 3. Overall view of unit (VT-5342)

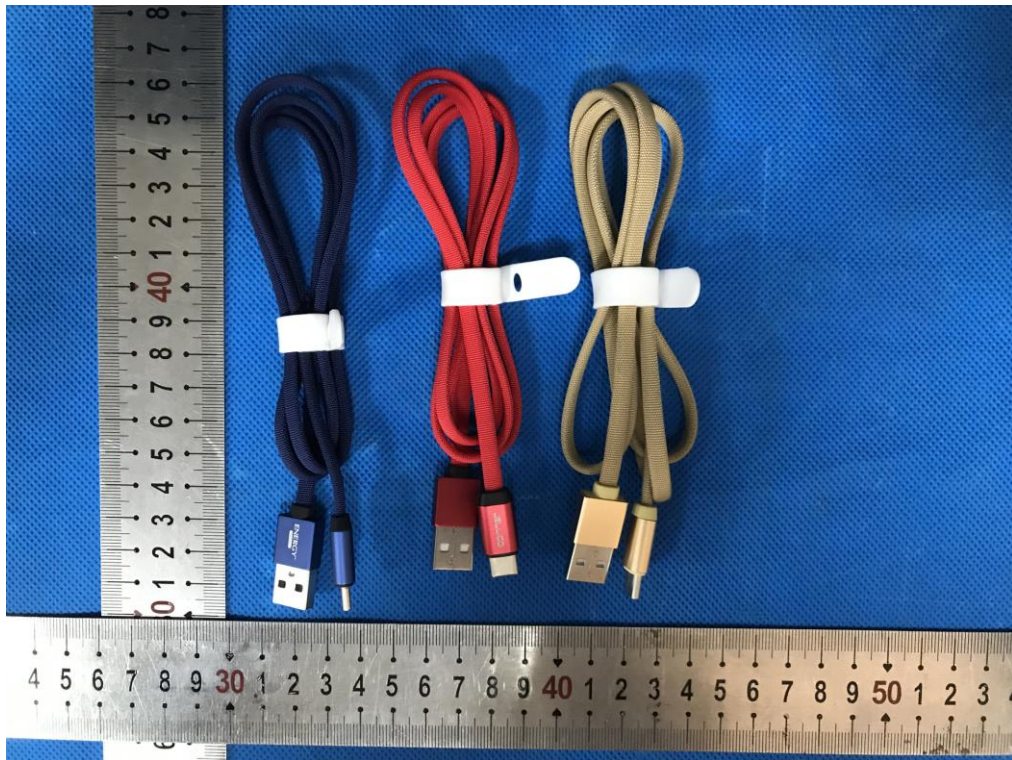

Figure 4. Overall view of unit (VT-5342)

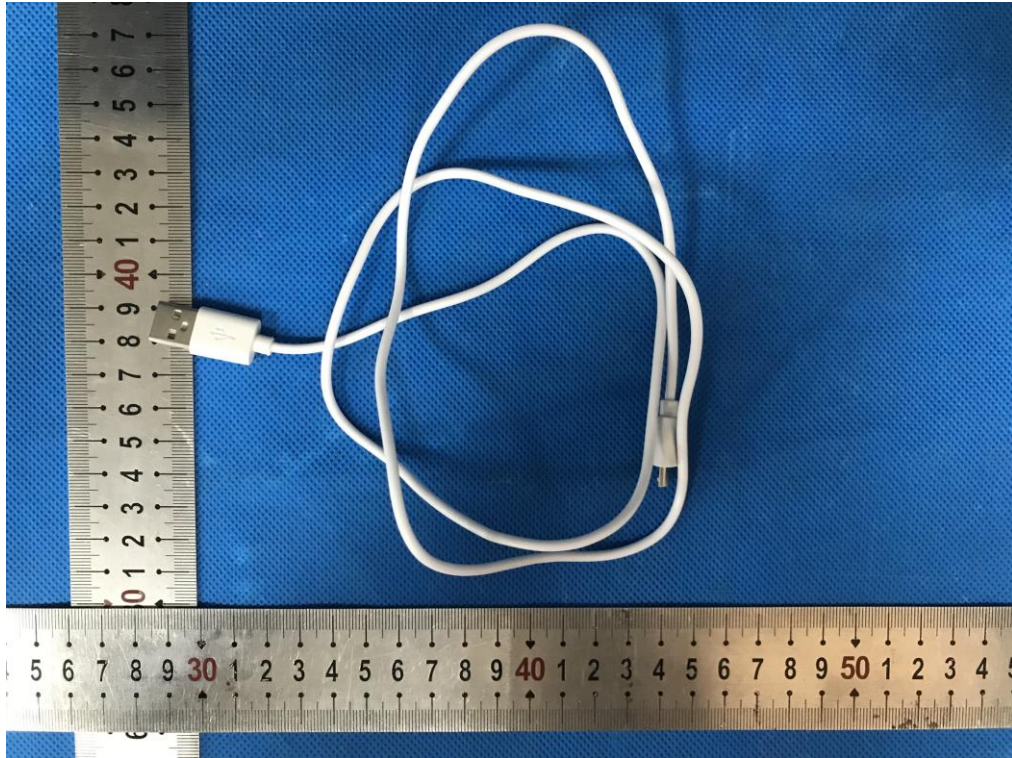

Figure 5. Overall view of unit (VT-5301)

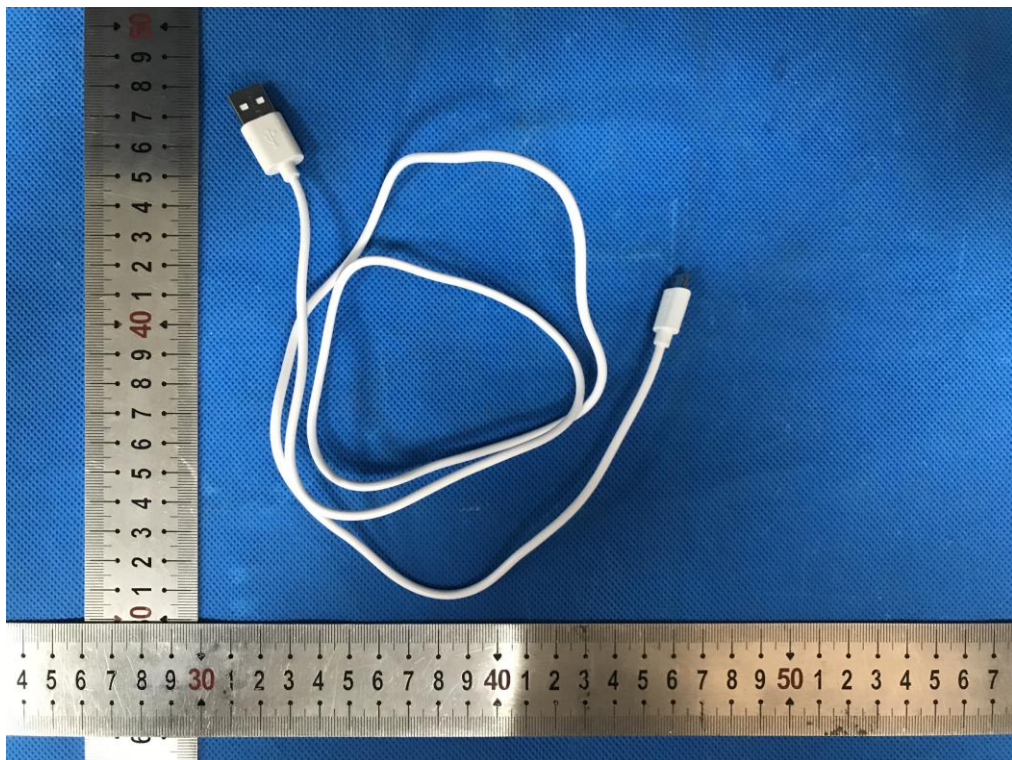

Figure 6. Overall view of unit (VT-5301)

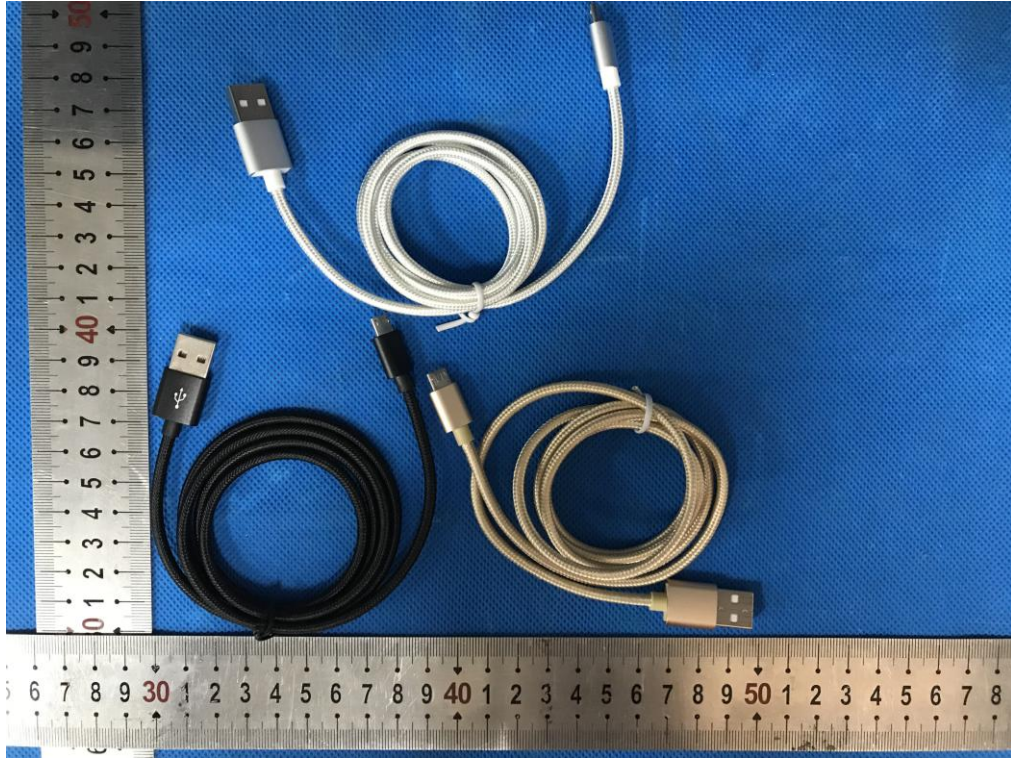

Figure 7. Overall view of unit (VT-5331)

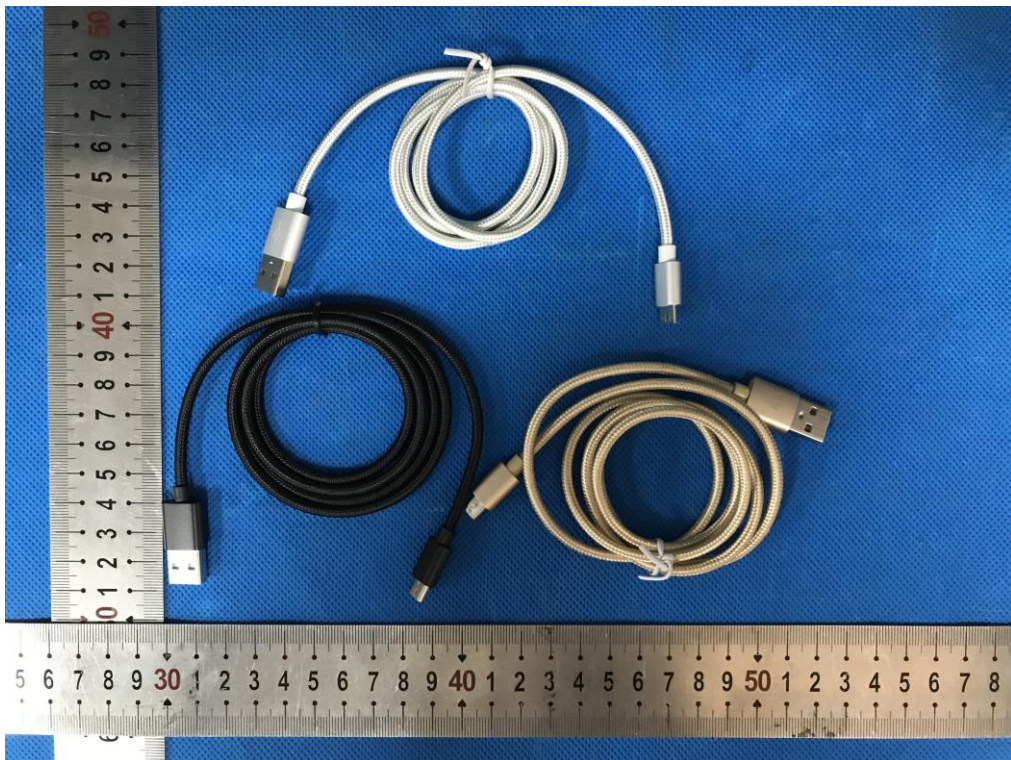

Figure 8. Overall view of unit (VT-5331)

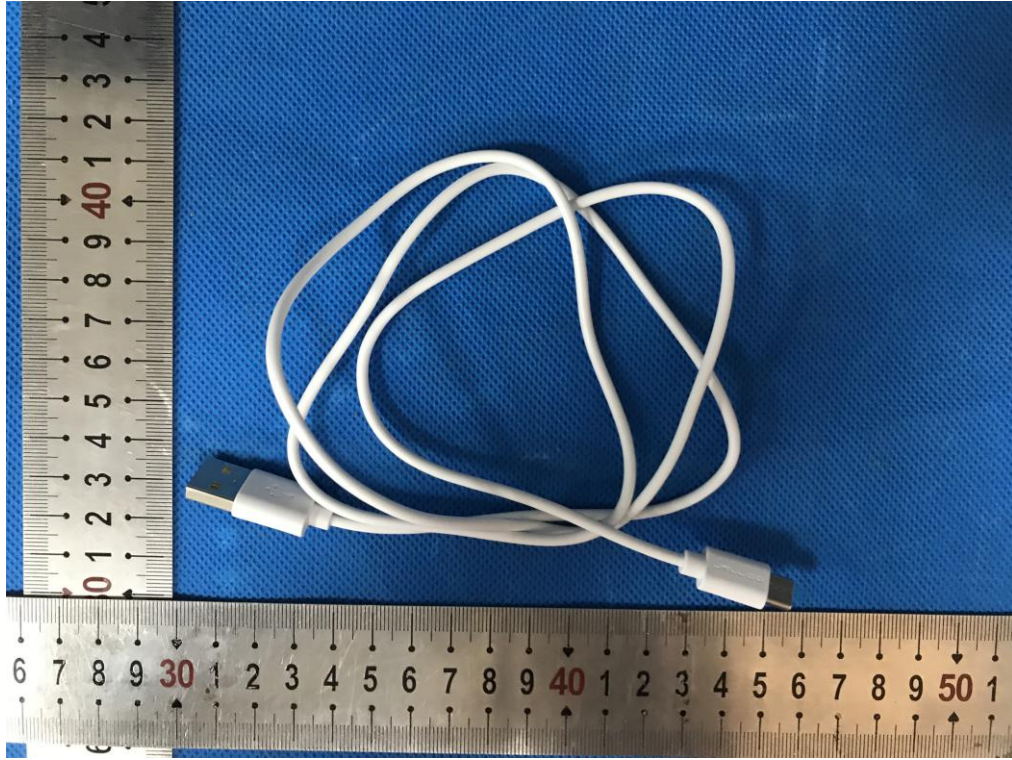

Figure 9. Overall view of unit (VT-5302)

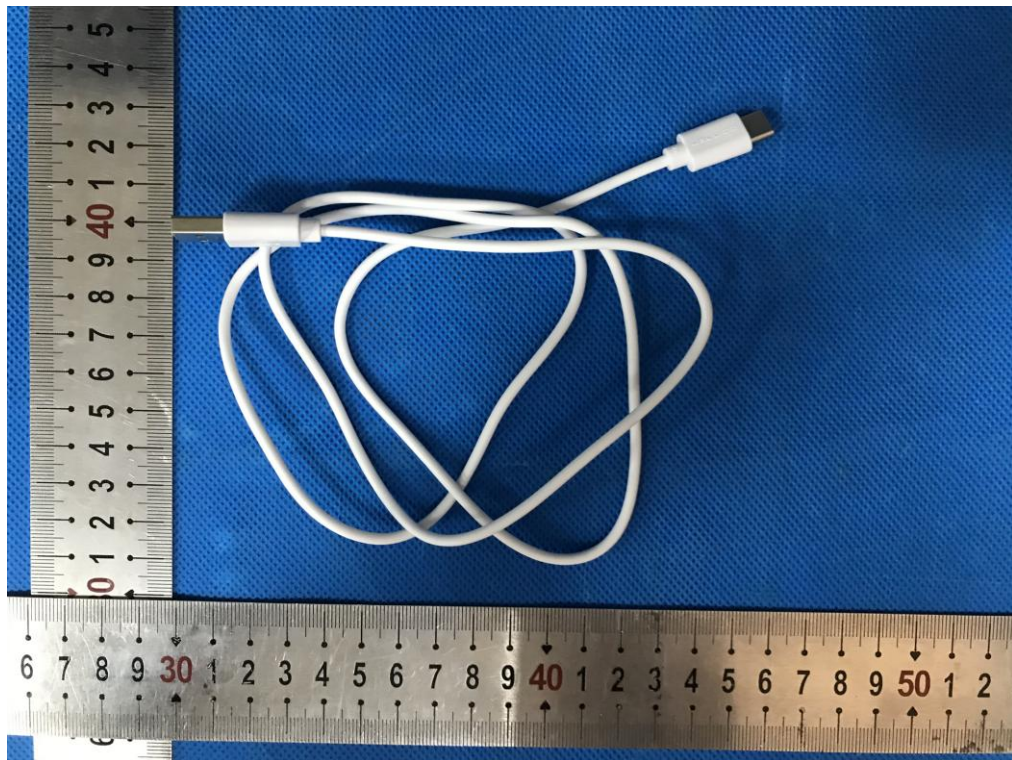

Figure 10. Overall view of unit (VT-5302)

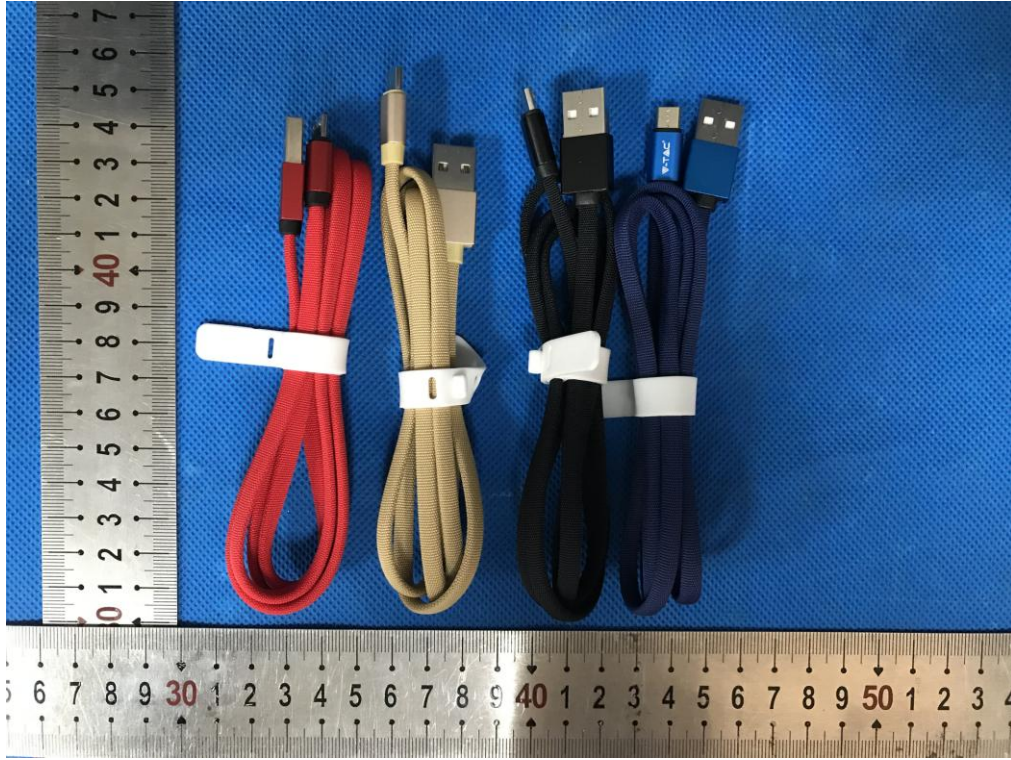

Figure 11. Overall view of unit (VT-5341)

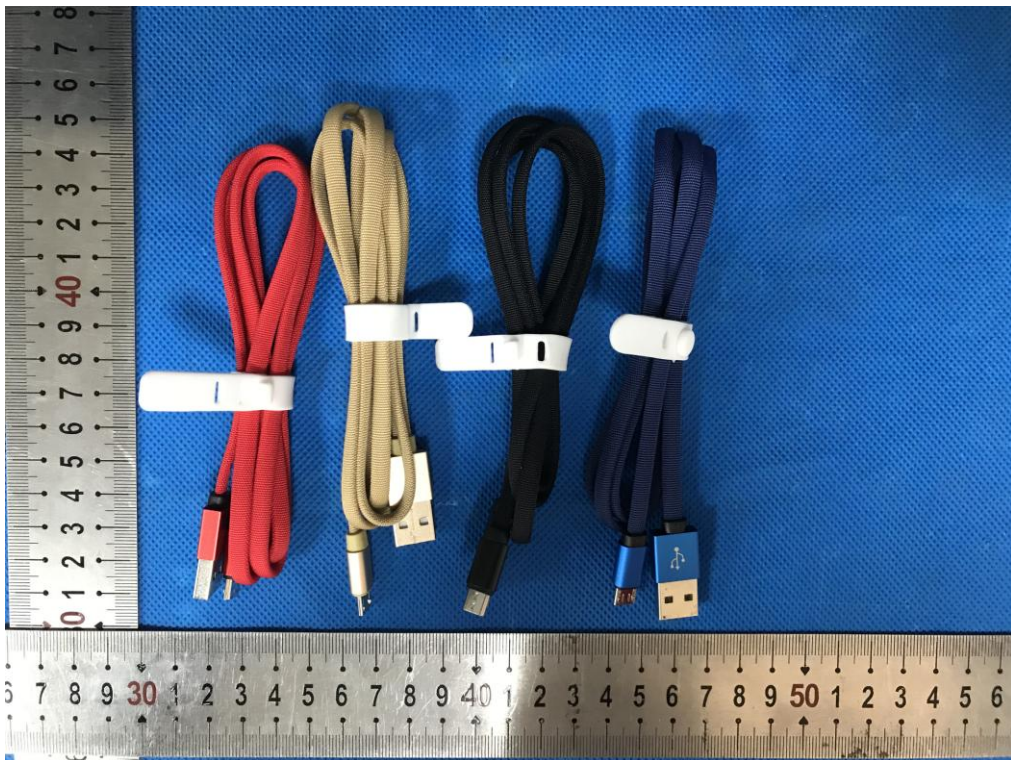

Figure 12. Overall view of unit (VT-5341)

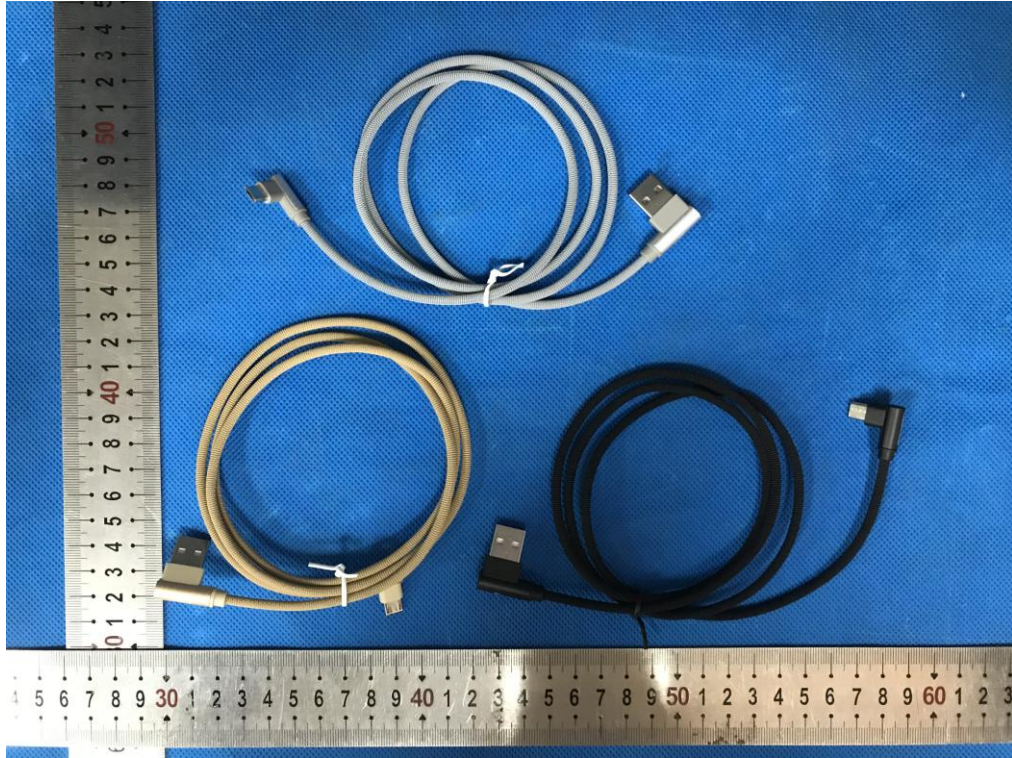

Figure 13. Overall view of unit (VT-5361)

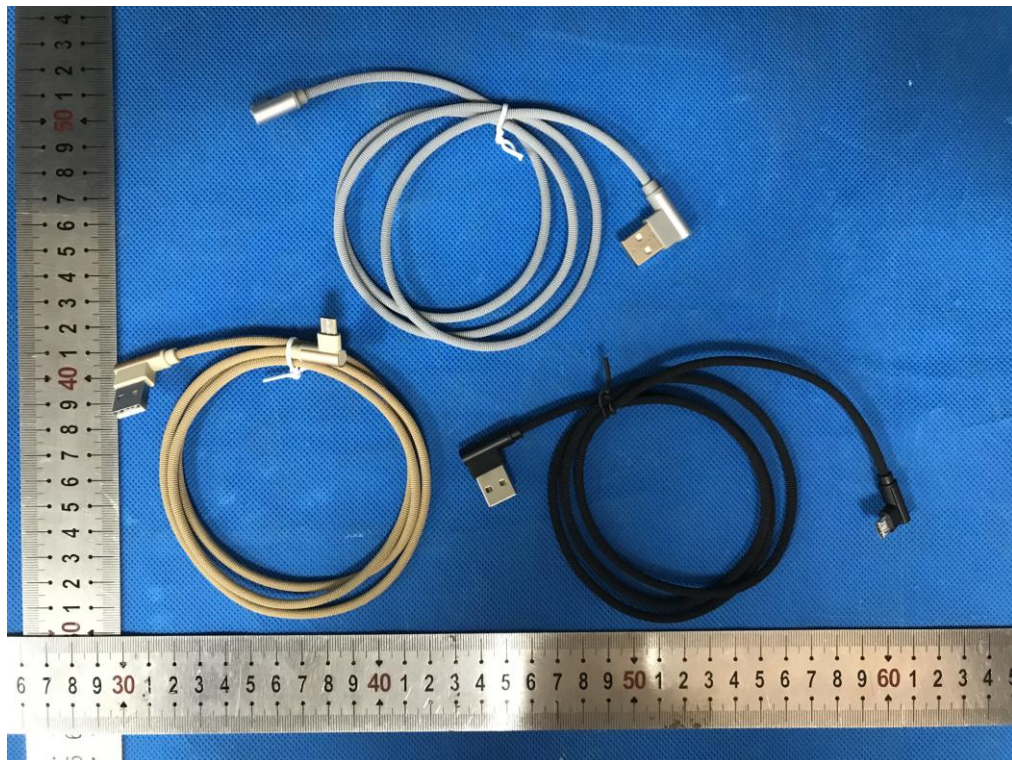

Figure 14. Overall view of unit (VT-5361)



Figure 15. Overall view of unit (VT-5334)



Figure 16. Overall view of unit (VT-5334)



Figure 17. Overall view of unit (VT-5352)

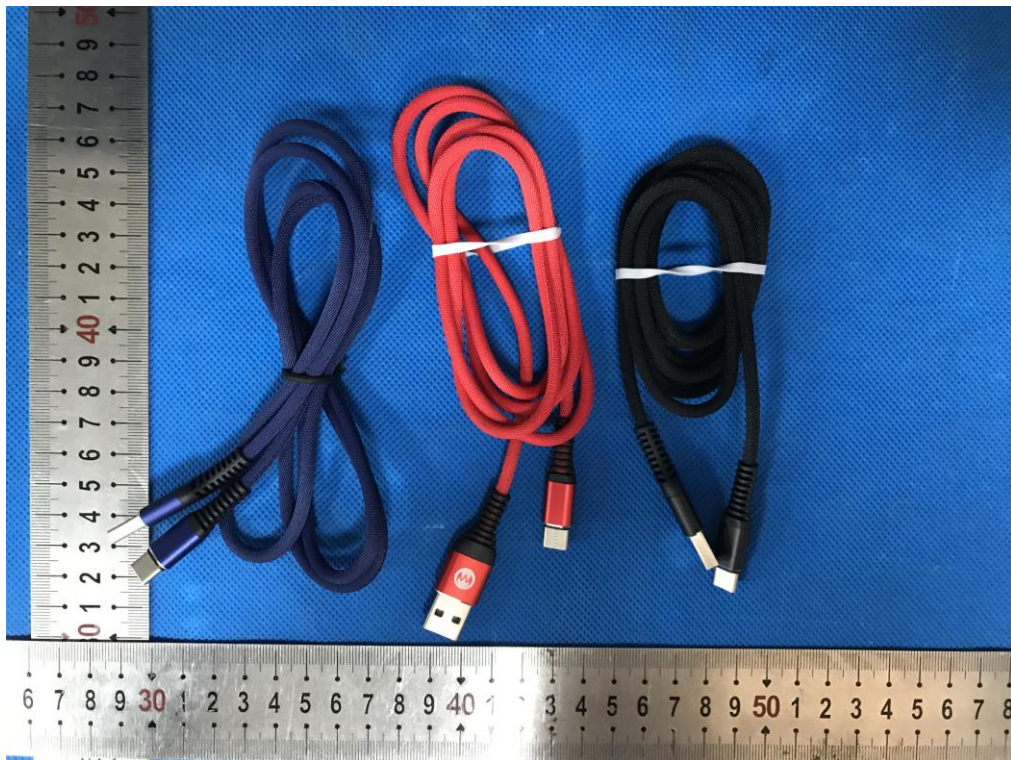

Figure 18. Overall view of unit (VT-5352)

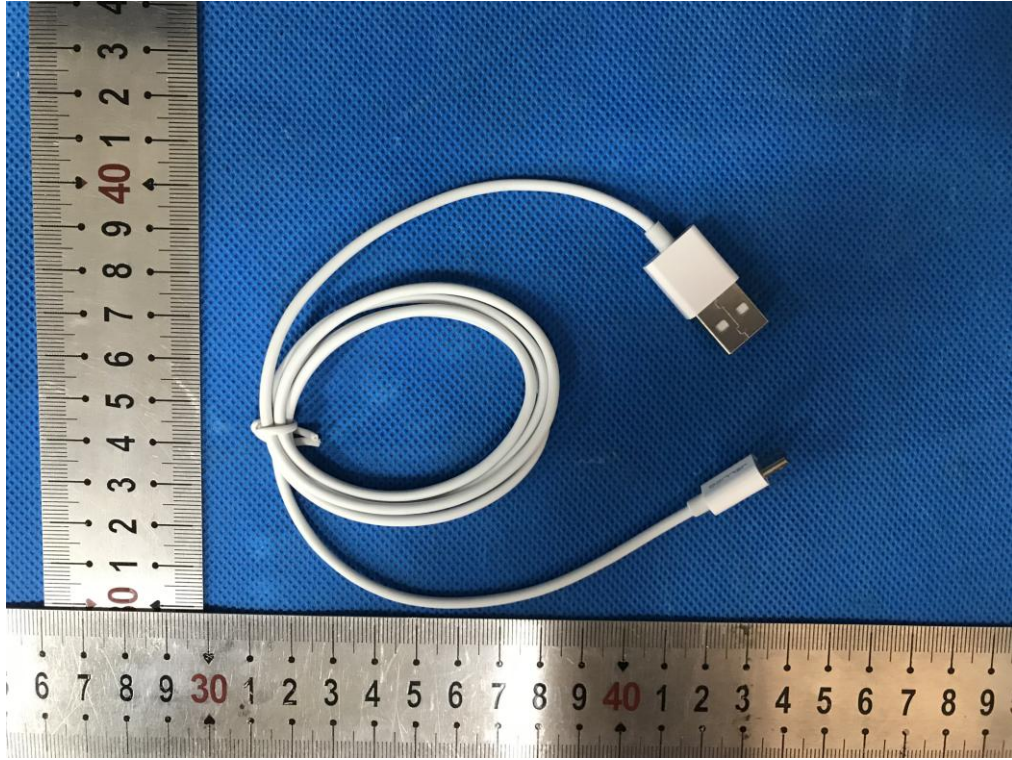

Figure 19. Overall view of unit (VT-5321)

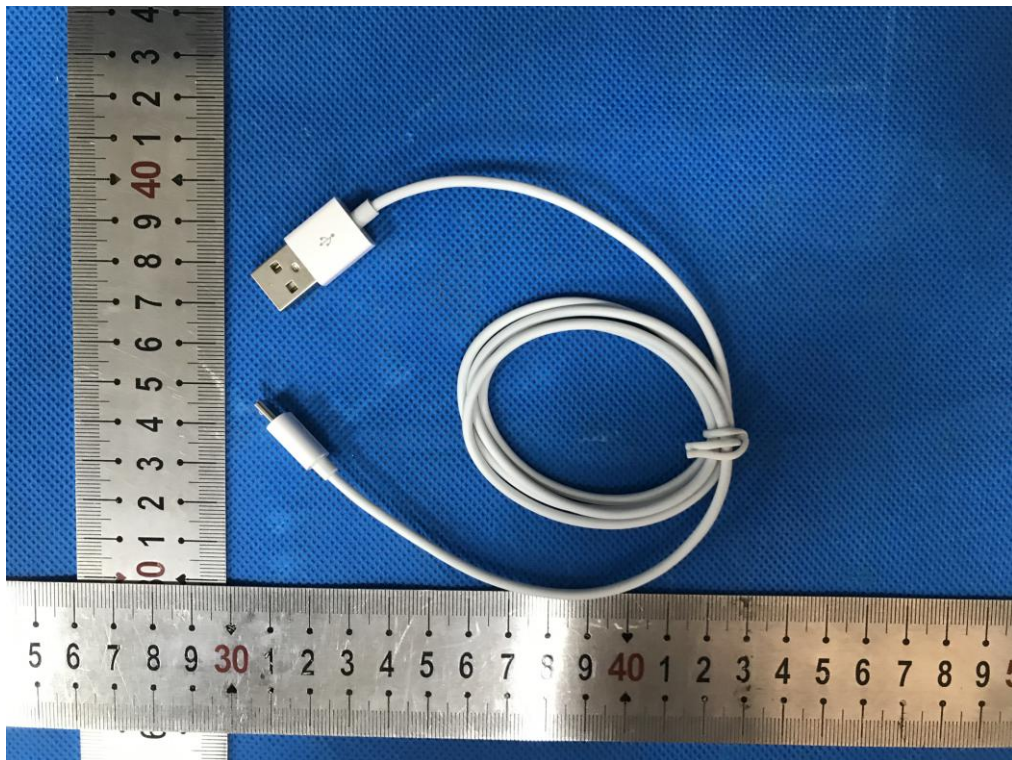

Figure 20. Overall view of unit (VT-5321)



Figure 21. Overall view of unit (VT-5362)



Figure 22. Overall view of unit (VT-5362)