

0 337 70/72



0 337 73/75

CONTENTS

Page

1. GENERAL CHARACTERISTICS	1
2. POSITIONING	1
3. TECHNICAL CHARACTERISTICS OF PANEL	2
4. TECHNICAL CHARACTERISTICS OF CONNECTORS	2
5. PERFORMANCES A 20°	2
6. DIMENSIONS	2
7. TYPICAL RJ45 CONNECTION.....	2
8. ACCESSORIES	3
9. STANDARDS	3
10. PERFORMANCES	4

1. GENERAL CHARACTERISTICS

Equipped with new-generation Soluclips for automatic fixing (screwless) on cabinet and enclosure uprights (the soluclips are designed to adapt to uprights of thickness ranging from 1.5 to 2mm max).

Universal mounting in all racks or cabinets with automatic earthing on unpainted uprights. Painted uprights can be connected to earth with a cord and a screw connection.

Equipped with rear cable guide to hold cable during maintenance.

Equipped with 4 cassettes of 6 LCS³ RJ45 Cat. 6A connectors with toolless fast connection, marked 568 A/B.

Supplied with different colour identification labels for each cassette (blue, white, yellow, orange).

Conforming to standards ISO/IEC 11801 edition 3.0 (2017) and ANSI/TIA 568.2-D.

19" panel - 1 U.

Cassettes removed automatically by simply pressing the button on the front.

Each connector can be removed individually.

Mounting a panel

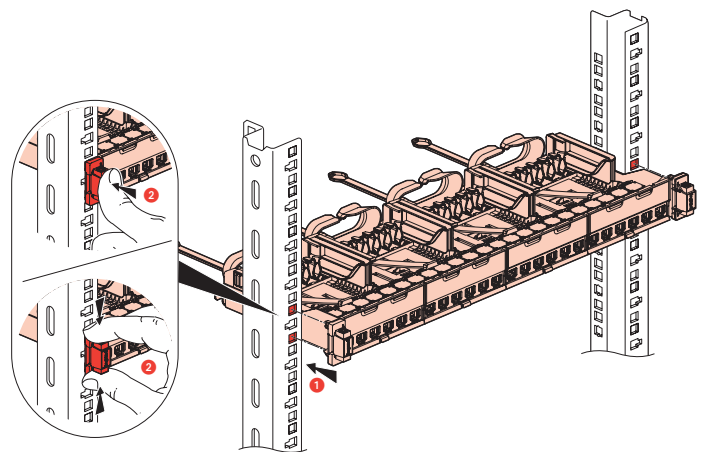

Mounting a cassette

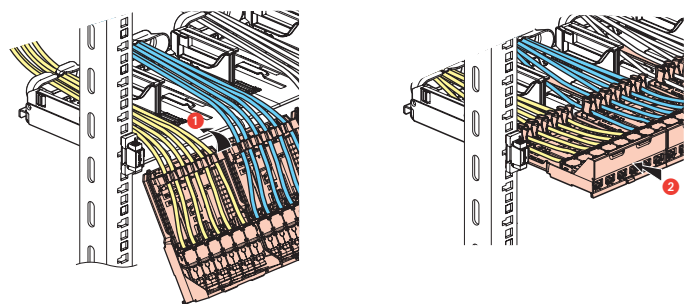

Removing a cassette

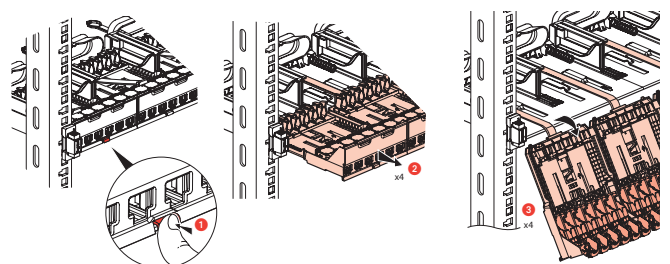

Description		UTP	STP	Weight (g)
	Panel with 24 RJ45 Cat. 6A UTP	0 337 70		1786
	Panel with 24 RJ45 Cat. 6A STP		0 337 72	2505
	Connector with 6 RJ45 Cat. 6A UTP	0 337 73		11
	Connector with 6 RJ45 Cat. 6A STP		0 337 75	40

2. POSITIONING

Connectors are connected at the front without a special tool.

- Connectors clip onto the panel individually

No need for cable ties: the cable is held in its cable guide in the cassette and by a concentric strand guide on the panel.

3. TECHNICAL CHARACTERISTICS OF PANEL

3.1 Material characteristics

Panel: DC01 galvanised sheet steel.

3.2 Electrical characteristics

Automatic grounding of cassette to panel
 Automatic grounding of panel to uprights through unpainted contact area.
 Ground lug on panel if additional grounding necessary.

3.3 Mechanical characteristics

Fixing to uprights without screws: Upright thickness 1.5 to 2mm
 For fixing to uprights outside tolerance, Soluclip can be removed and replaced by screws.

4. TECHNICAL CHARACTERISTICS OF CONNECTORS

4.1 Mechanical characteristics

Max. number of connections and disconnections: 5 without refreshing the wiring.
 Endurance: 2500 movements (plug insertion/withdrawal).

4.2 Material characteristics

Contacts: Gold/nickel, minimum thickness of gold > 0.8 µm.
 Metal parts: Bronze, nickel, platinum, gold.
 Polycarbonate PBT.

4.3 Electrical characteristics

Breakdown voltage ≥ 1000 V.
 Contact resistance ≤ 20 mΩ.
 Insulation resistance ≥ 500 mΩ at 100 Vdc.
 "Tested and independently certified to comply with IEC 60512-99-001 and IEC 60512-99-002 for PoE support up to 90w (Type 4)."

4.4 Climatic characteristics

Storage temperature : 10°C to +70°C
 Operating temperature : -10°C to +60°C

5. PERFORMANCE A 20°

Maximum length of Permanent Link based on architecture

	Maximum cord length*	Maximum Permanent Link	Total Channel
2 Connector Channel	10m	89m	99m
3 Connector Channel	10m	88m	98m
4 Connector Channel	10m	87m	97m

* = sum of 2 cords

Note: calculations based on ISO/IEC 11801. Legrand products support the 100m 2-connector channel, confirmed by laboratory testing.

6. DIMENSIONS

Dimensions of panels 0 337 50/51

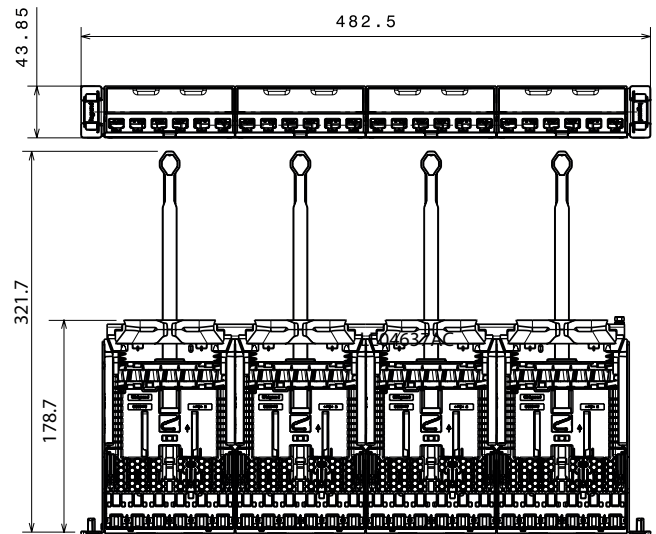

Dimensions of connectors 0 337 53/54

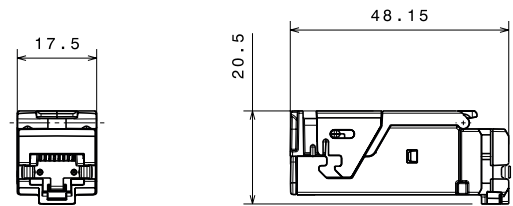

7. TYPICAL RJ45 CONNECTION

Takes the following plugs:
 RJ 11 (4 contacts), RJ 12 (6 contacts), RJ 45 (9 contacts).

T568 A and B dual colour code:

- UTP (8 contacts)
- FTP (9 contacts)

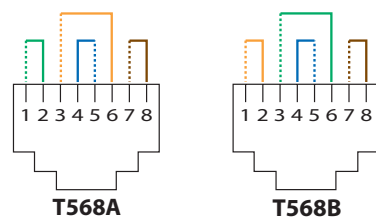

Colour code and contact number

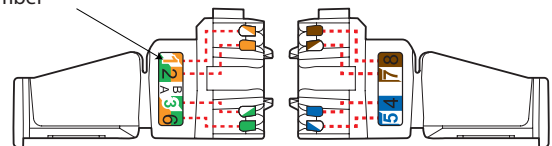

Identification number
 UTP : HD 61
 STP : HD 63

Category colour code :
 Cat. 6A yellow

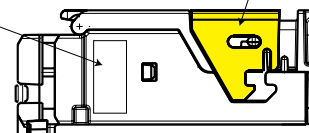

Permissible conductors:

- Solid/Stranded : 0.4 to 0.65 mm, AWG 26 to 22
- Polyethylene conductor insulation: Ø 0.85 to 1.7 mm on insulation

Number of wires to be connected per connection: 1

RJ45 connectors are equipped with a locking nut. They do not require a special tool and can be re-wired if a mistake is made.

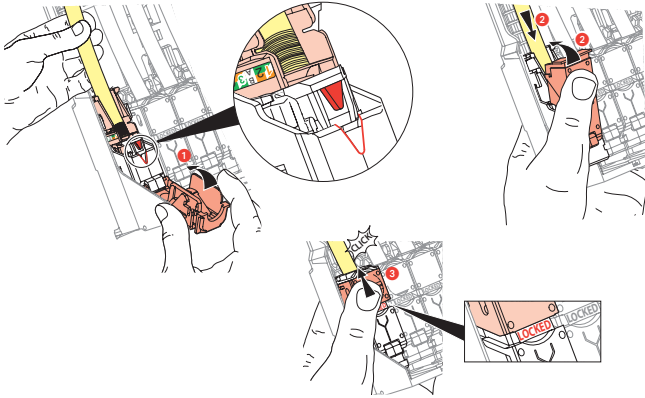

This system makes it easy to spread pairs before fitting them onto the connector.

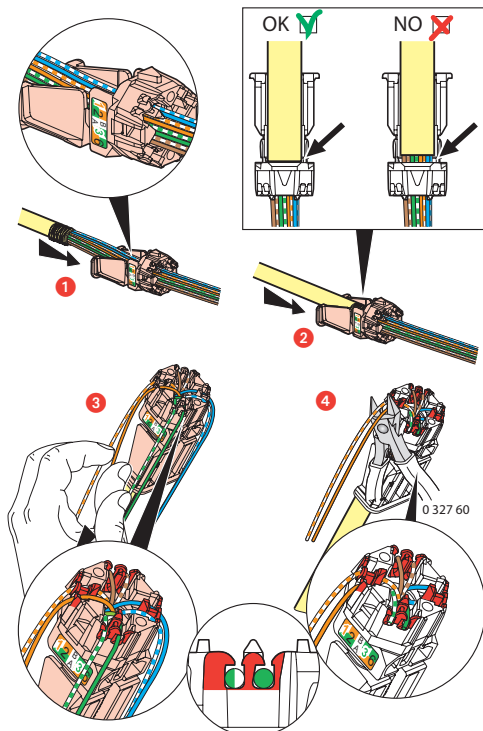

Spreading the cables and positioning the sleeve firmly in the spreader ensures that a pair-breakage distance of 13 mm is kept between pairs, as required by the standard.

Spreading pairs at 90° to the cable ensures the best possible performance.

8. ACCESSORIES

- **0 337 57:** Blanking cassette

Used to fill gaps in the panel.

- **0 337 56:** Port blanking plate

Blanking plate with 6 separable ports

Used to block up individually, partially or fully 1 to 6 ports (cassette with 6 ports) or 1 to 12 ports (HD cassette).

- **0 337 59:** Cable guide

2 cable guides to be clipped onto new-generation Soluclips.

Manages cables laterally by holding them and tilting them horizontally and vertically.

Each cable guide is guaranteed to hold up to 12 Cat6a cords

9. STANDARDS

ISO/IEC 11801 series : International standard for generic cabling for customer premises

ANSI/TIA 568 series : North American standard for generic cabling for customer premises

EN 50173 series : European standard for generic cabling for customer premises

IEC 60603-7 series : International standard for connector specifications

Connectors are compliant to requirements for the following remote powering applications

IEEE 802.3af , IEEE 802.3at , IEEE 802.3bt : "Power over Ethernet", Types 1 to 4, up to 90w.

10. SYSTEM PERFORMANCES

10.1 Permanent link performances with F/UTP cable

Return loss

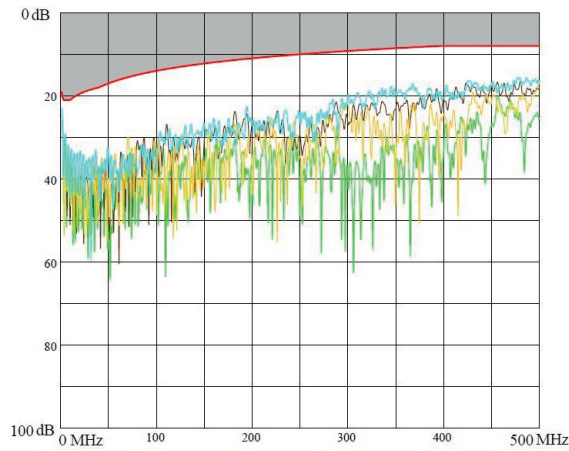

Attenuation

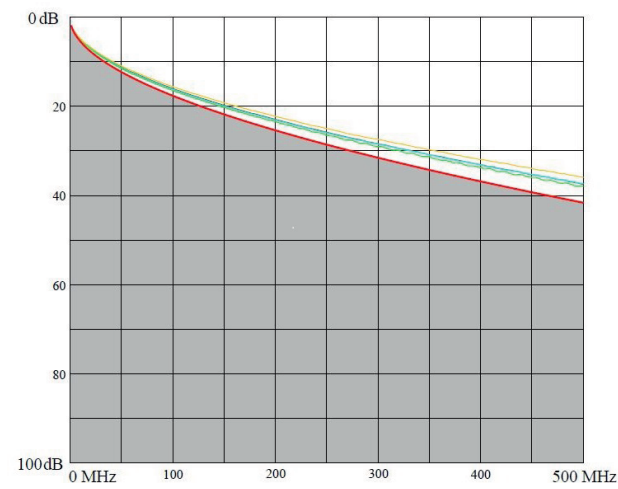

NEXT (Near end Crosstalk Attenuation)

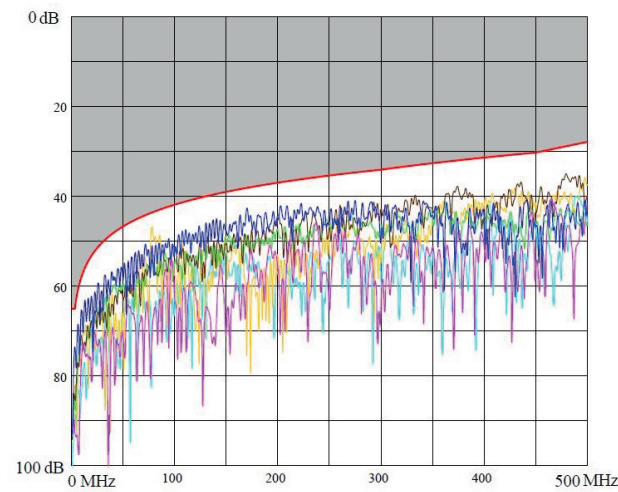

PS NEXT (Power Sum NEXT)

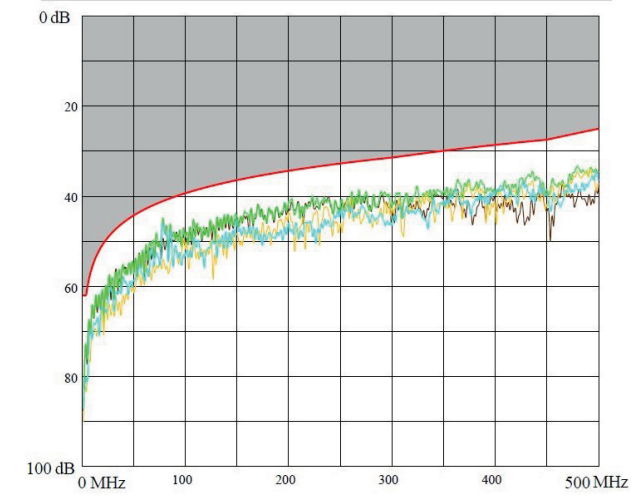

ACR (Attenuation to Crosstalk Ratio)

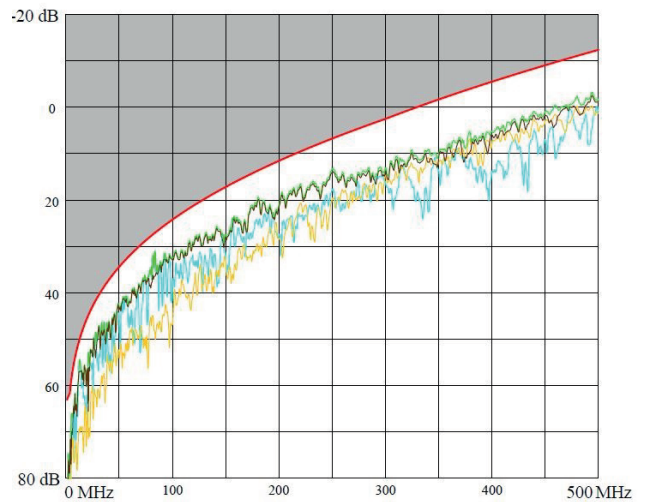

ELFEXT (Equal Level End Crosstalk Attenuation)

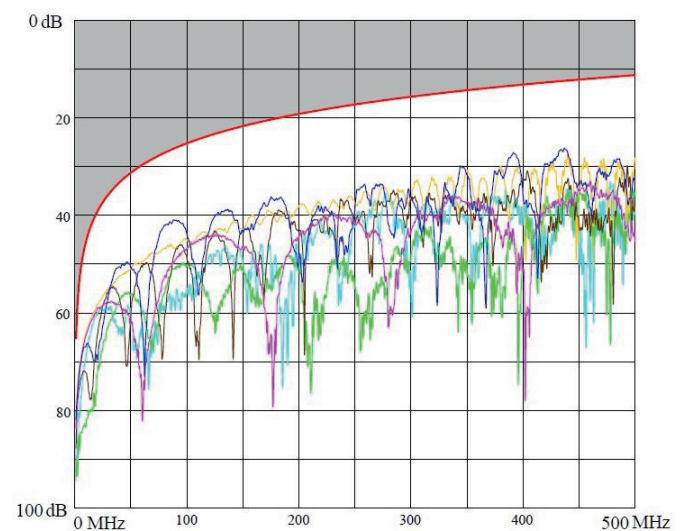

Delay skew

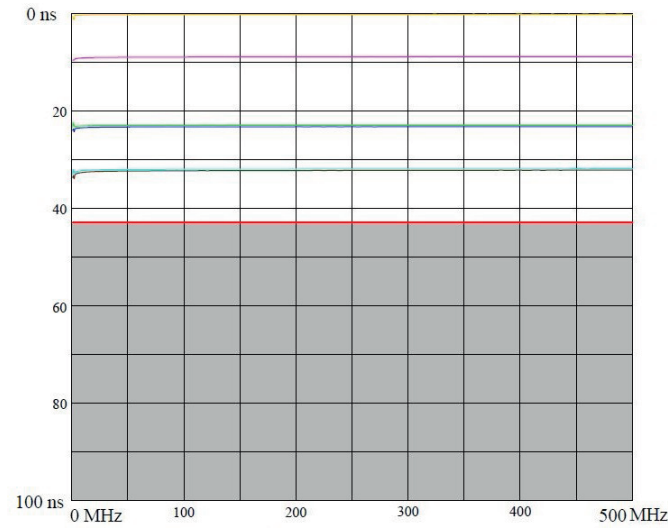

NEXT (Near end Crosstalk Attenuation)

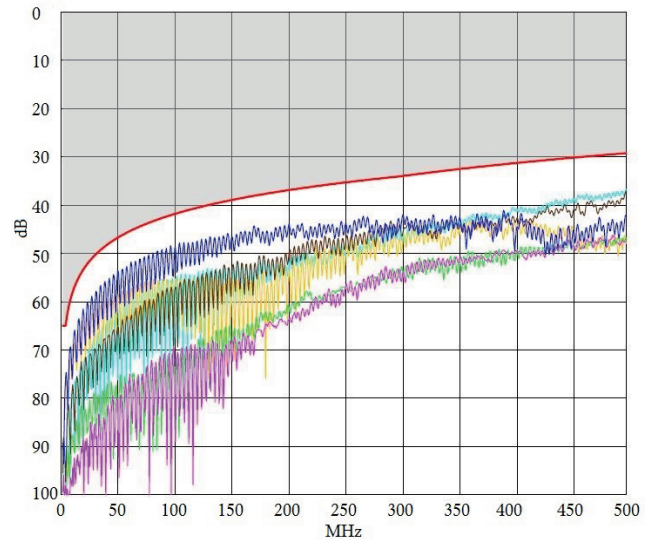

■ 0.2 Permanent link performances with S/FTP cable

Return loss

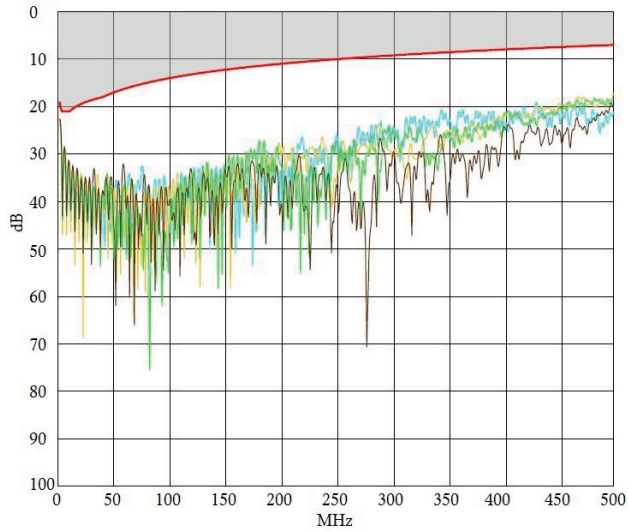

PS NEXT (Power Sum NEXT)

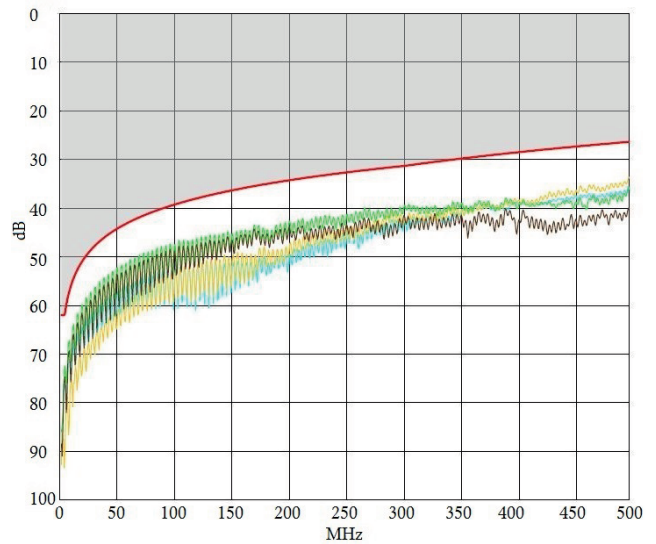

Attenuation

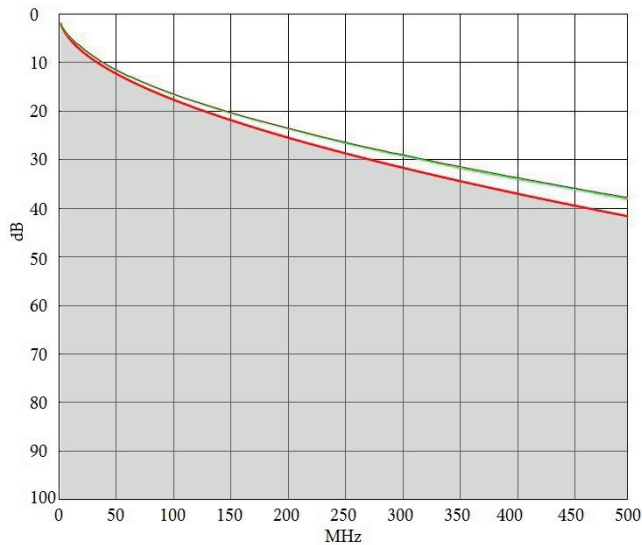

ACR (Attenuation to Crosstalk Ratio)

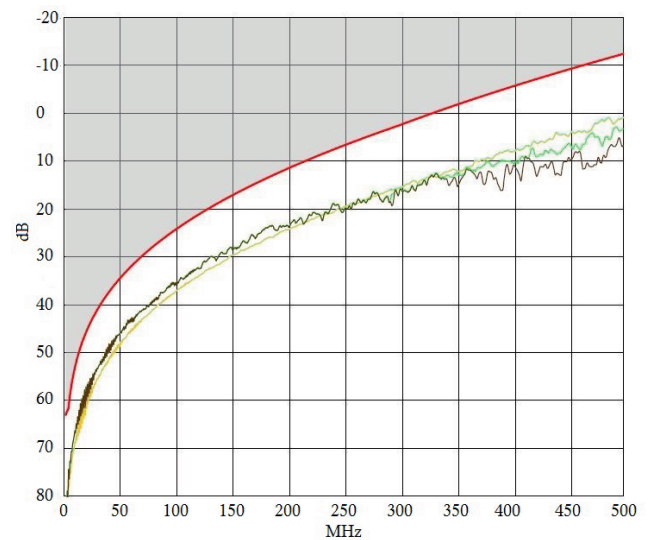

ELFEXT (Equal Level End Crosstalk Attenuation)

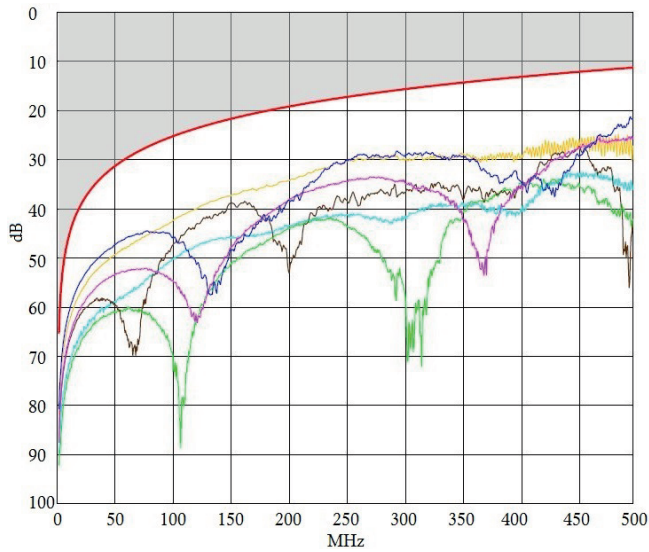

Attenuation

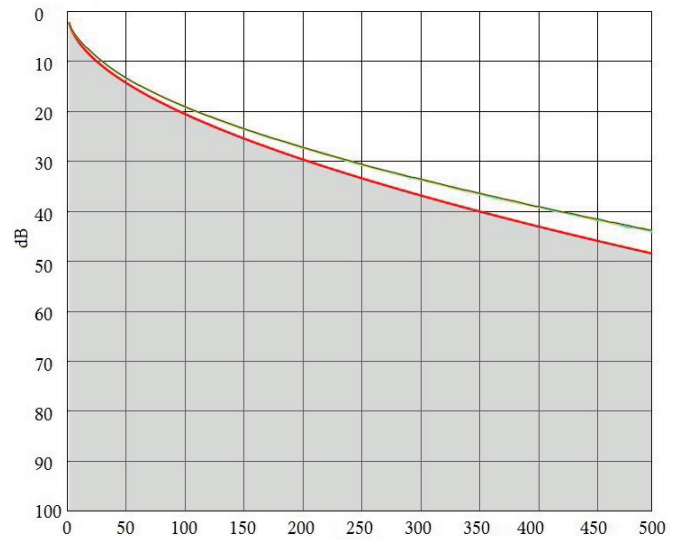

Delay skew

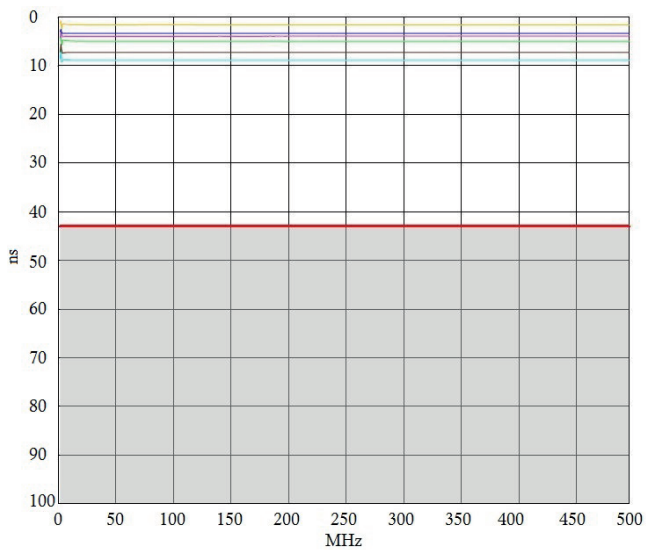

NEXT (Near end Crosstalk Attenuation)

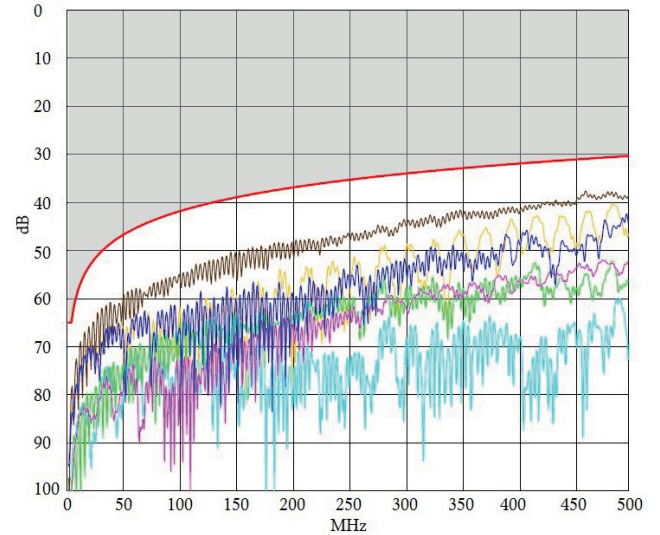

0.3 Channel performances

Return loss

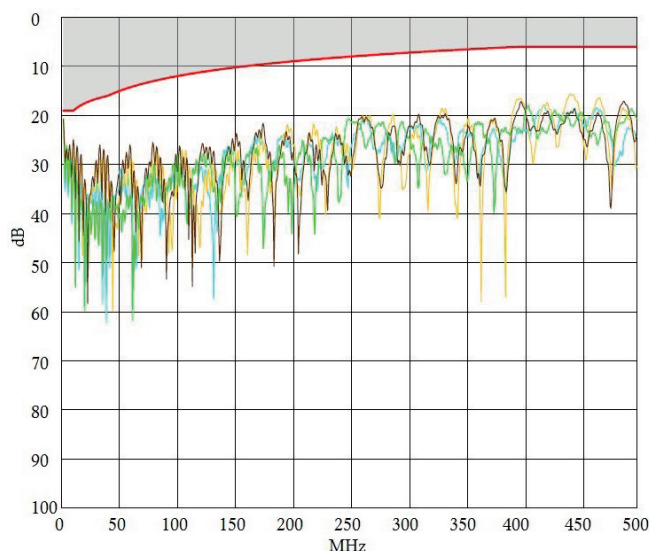

PS NEXT (Power Sum NEXT)

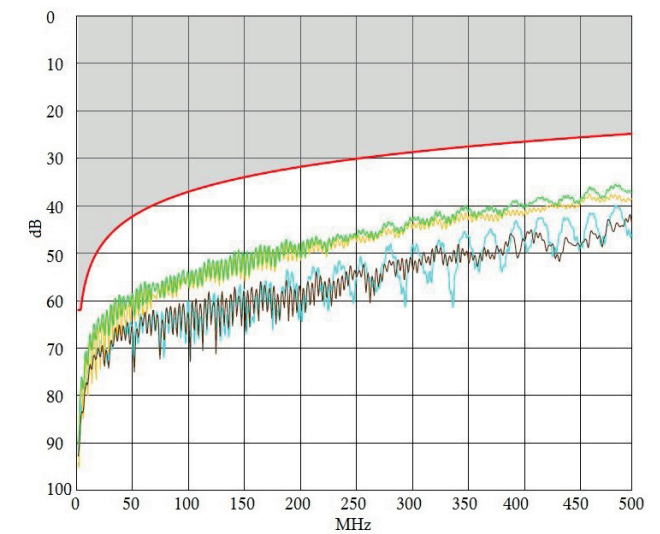

ACR (Attenuation to Crosstalk Ratio)

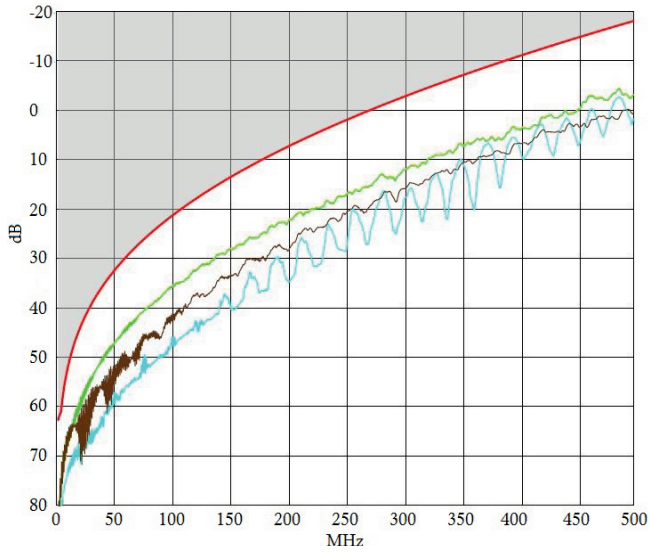

ELFEXT (Equal Level End Crosstalk Attenuation)

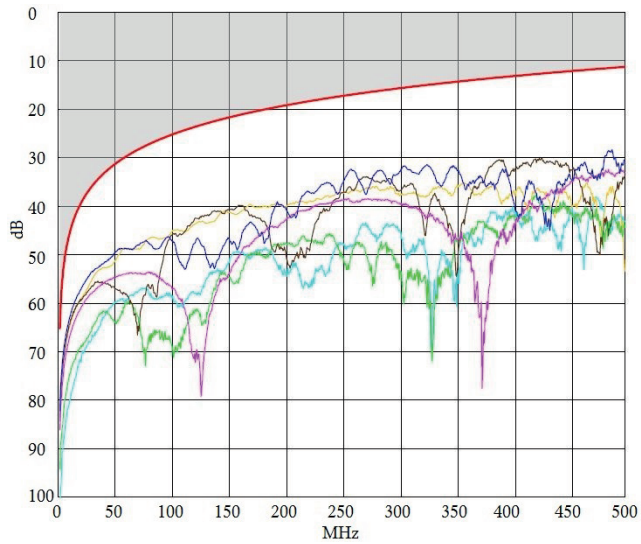

Delay skew

