

## PCE data sheet

article#	<b>0932-10v</b>
article description	<b>CEE-plug 32A 3p 24/42VDC IP67 TWIST</b>
description long	CEE-plug 32A 3p 24/42VDC IP67 TWIST housing material: PA6 rated current: 32A number of poles: 3 (3P) clock-position: 10h rated voltage/frequency: 24/42V DC contacts: brass nickel plated connection technology: screw terminals IP protection class: IP67
GTIN (EAN)	9003399616037
country of origin	AT
customs number	85366990
net weight	0.169 kg
packaging quantity	10
minimum order quantity	10

ETIM 7.0	EC000140
IEC-amperage	32 A
Number of poles	3
Voltage acc. EN 60309-2	<50 V DC grey
Clock hour position	10 h
Identification colour	White
Degree of protection (IP)	IP67
Connection system	Schraubklemme
Cable entry	Verschraubung
Angle of plug	Straight
Material	Plastic

a	135 mm
b	71 mm
K (cable Ø)	9,5-24 mm
SW	48 mm
wire flexible	1-10 mm <sup>2</sup>
contact screws	160 Ncm
strain relief	600 Ncm
dismantling length	70 mm
stripping length	14-16 mm

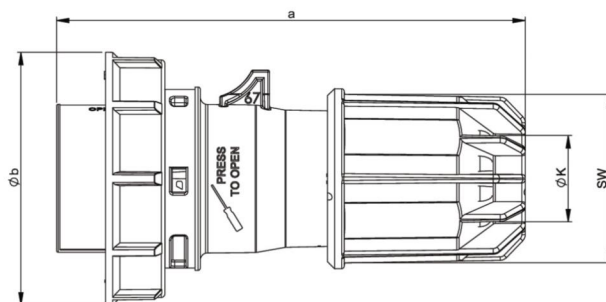

[www.manufacturer-safety.info](http://www.manufacturer-safety.info)