

LED Candle Light B2C - Frosted E27 40W (Low flicker)

Authorized Licensee for TOSHIBA trademark



1. Specification:

A. General Data

Model	Classic Candle E27 40W 3000K	Classic Candle E27 40W 4000K	Classic Candle E27 40W 6500K
P/N	DELS-CD344P727AE21	DELS-CD444P727AE21	DELS-CDC44P727AE21
Westnet Code	00168820	00168826	00168828
Rated Voltage	230 VAC	230 VAC	230 VAC
Frequency	50 Hz	50 Hz	50 Hz
Rated Wattage	4.7W	4.7W	4.7W
Deviation Tolerance of Wattage	±10 %	±10 %	±10 %
Displacement Factor	0.5(typical)	0.5(typical)	0.5(typical)
Rated Current	40 mA	40 mA	40 mA
Maximum Input Current	47 mA	47 mA	47 mA
Start On	<0.5S	<0.5S	<0.5S
Warm-up time up to 60% of the full light output	<1S	<1S	<1S
Dimmable	NO	NO	NO
Beam Angle	220°	220°	220°
Stroboscopic effect metric (SVM)	≤ 0.9	≤ 0.9	≤ 0.9
Flicker metric (PstLM)	≤ 1	≤ 1	≤ 1
Energy Efficiency Class(EEC)	F	F	F
Safety requirements	CE		
Applicable Environments	Dry locations; Not suitable for totally enclosed fixtures		
Ingress protection rating	IP20		
Impact resistance	N.A		
Incandescent Equivalent	40W	40W	40W
Base	E27	E27	E27
Photobiological Group	RG 0	RG 0	RG 0

* Displacement factor tolerance +/- 10%

B. Light Data

Color	Warm white	Neutral White	Cool White
Color Temperature (CCT)	3000K	4000K	6500K
Rated Lumen Output*	470lm		
Color Rendering Index	≥ 80		
Efficacy(Useful)*	100 lm/W		
Efficacy(Total)*	100 lm/W		
Color Consistency**	6 Step MacAdam Ellipse (6 SDCM)		

*tolerance +/- 10%

** 3000K center point (0.4338, 0.403) · 4000K center point (0.3818, 0.3796) · 6500K center point (0.3123, 0.3283)

C. Lifetime

(Supplied Voltage:AC230V; Ambient Temperature: 25°C)

Lumen Maintenance Factor	70%of the rated lifetime
Rated Lifetime – L ₇₀ B ₅₀	15,000 hrs
Switching Cycles	$\geq 12,000$

D. Temperature Operation

Normal operation temperature	-20°C ~ 40°C
Relative Humidity	10%~ 90%

E. Geometric Data

Model	Classic Candle E27 40W
Maximum overall length	100 ± 2 mm (3.94 ± 0.08 inch)
Maximum diameter	36.5 ± 2 mm (1.44± 0.08 inch)
Mass	20.5 ± 3 g

F. Environmental relevant materials

Mercury (Hg)	Comply with RoHS Directive 2011/65/EU
Lead (Pb)	
Cadmium(Cd)	
Hexavalent Chromium(Cr6+)	
Polybrominated Biphenyls(PBBs)	
Polybrominated Diphenyl Ethers(PBDEs)	
Bis (2-ethylhexyl) phthalate(DEHP)	
Butyl benzyl phthalate(BBP)	
Dibutyl phthalate(DBP)	
Diisobutylphthalate(DIBP)	

2. Outline Drawing

Unit : mm

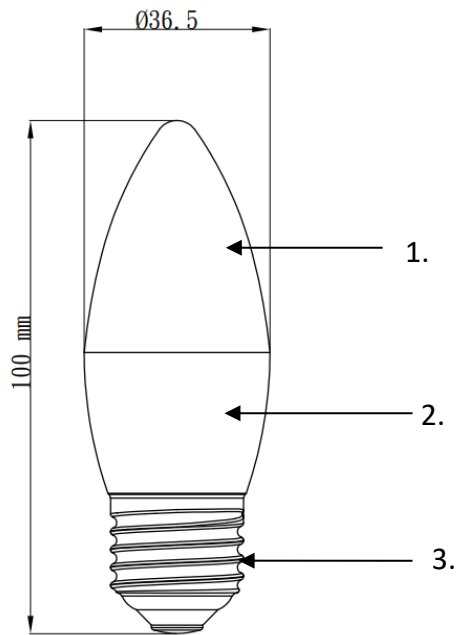

Material Information

1. Globe: Plastic
2. Body: Plastic
3. Base: Metal

3. Light Distribution Curve

FWHM 220°

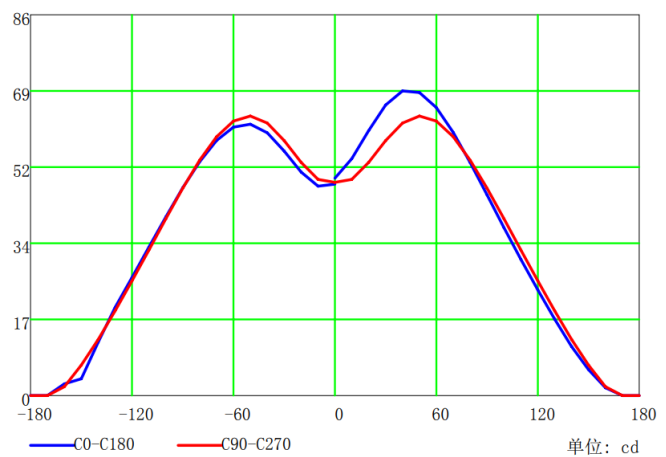
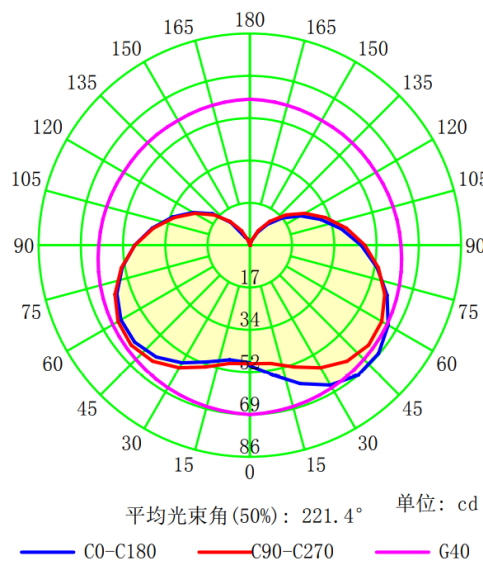

4. Spectrum Distribution

3000K: DELS-CD344P727AE21

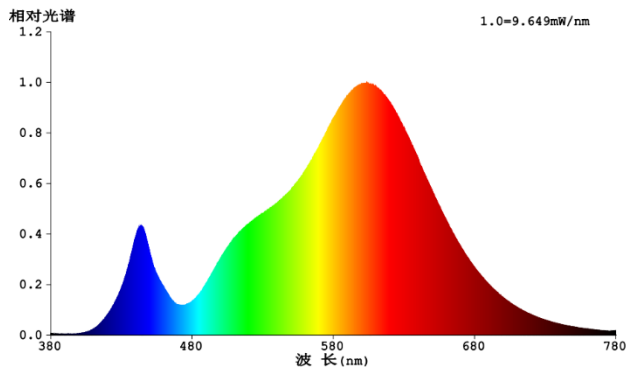

4000K: DELS-CD444P727AE21

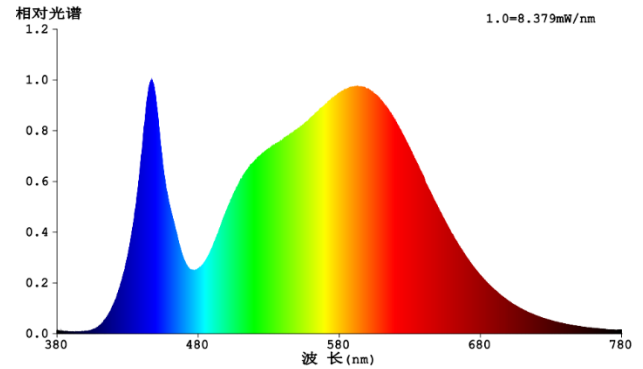

6500K: DELS-CD444P727AE21

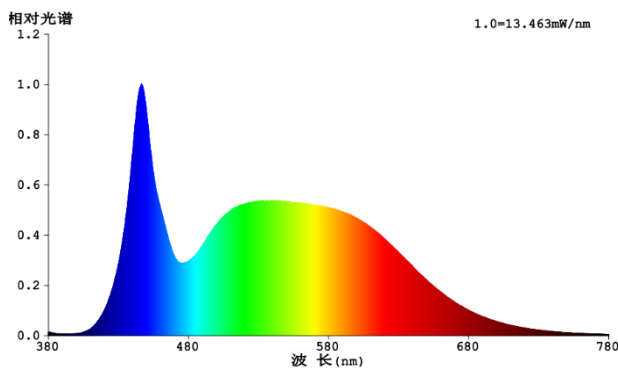

5. Warnings

Before replacing, turn off power and let lamp cool to avoid electrical shock or burn.

6. Cautions

Only to apply in dry and most of open fixtures with lamp-holders that offer sufficient space (10 mm free air space). Not intended for use with emergency light fixtures for exit lights.

7. Notes

All characteristics are estimated at room temperature (25°C), free air burning, base up burning position and at rated voltage. In view of the complex manufacturing process for light above for the technical LED parameters are merely statistical values that do not necessarily correspond to the actual technic individual products may vary from the typical values.

8. Logistic information

Model	Classic Candle E27 40W 3000K	Classic Candle E27 40W 4000K	Classic Candle E27 40W 6500K
Pieces per pack	1	1	1
EAN code on pack	4711112384570	4711112384587	4711112384594
Size of pack	38* 38 * 108mm	38* 38 * 108mm	38* 38 * 108mm
Weight per pack (G.W)	31.5g	31.5g	31.5g
Packs per inner box	N/A	N/A	N/A
EAN code on inner box	N/A	N/A	N/A
ITF code on inner box	N/A	N/A	N/A
Size of inner box	N/A	N/A	N/A
Weight per inner box(G.W)	N/A	N/A	N/A
Packs per outer box	100	100	100
EAN code on outer box	N/A	N/A	N/A
ITF code on outer box	14711112384577	14711112384584	14711112384591
Size of outer box	400*210*235mm	400*210*235mm	400*210*235mm
Weight per outer box(G.W)	3.52kg	3.52kg	3.52kg

Packing Photograph

4711112384570



4711112384587



4711112384594



9. ERP Label

DELS-CD344P727AE21 / DELS-CD444P727AE21 / DELS-CDC44P727AE21

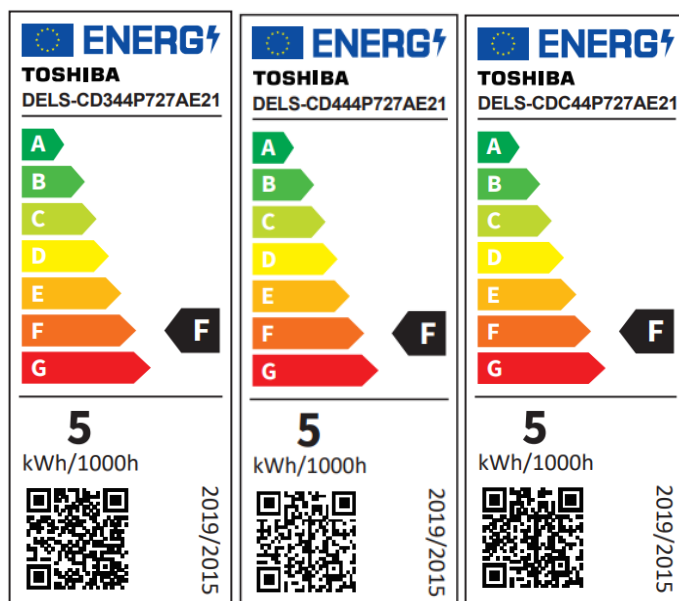

*Suppliers have to use the EPREL official website to generate a QR-code by a pre-registration.

10. Conformity

2014/35/EU; Low Voltage Directive	EN 62560:2012+A1:2015 、 EN62471:2008 EN 62493:2015 、 IEC/TR 62778: 2014
2014/30/EU; EMC Directive	EN 55015: 2013+A12015 、 EN 61000-3-2:2014 、 EN 61000-3-3: 2013 EN 61547:2009
2009/125/EC; ErP Directive	(EU) 2019/2015 、 (EU) 2019/2020 、 (EU) 2021/340 、 (EU) 2021/341
2011/65/EU+(EU)2015/863; RoHS Directive	EN 50581: 2012