

wymiary w [mm]

dimensions [mm]

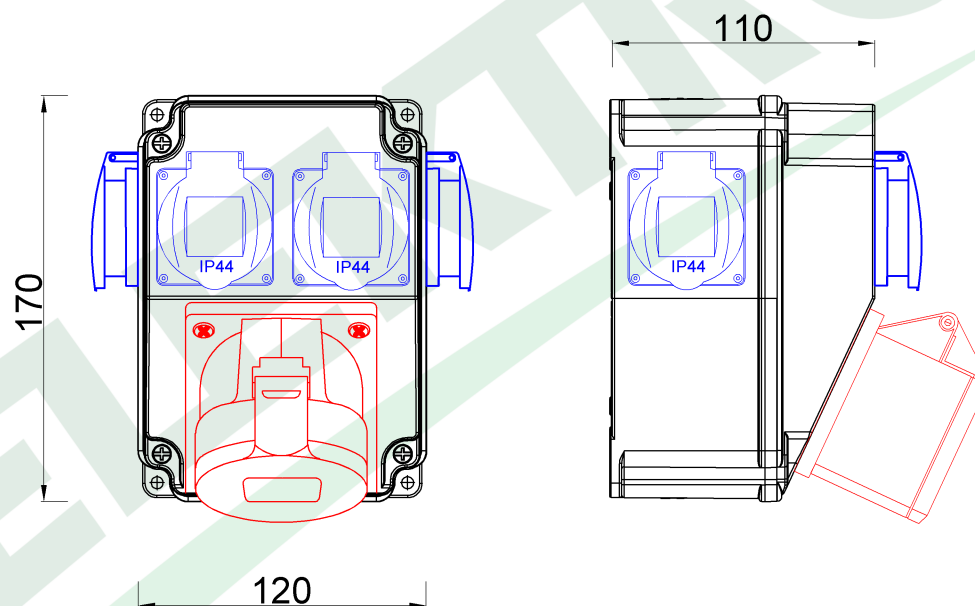
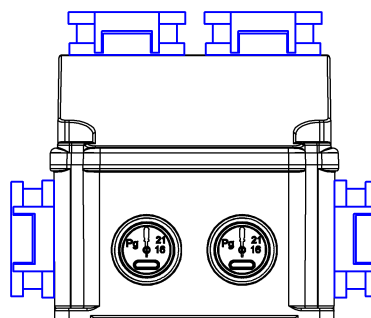

PARAMETRY
PARAMETERS

obudowa box	IP44
gniazda sockets	IP44
dławica cable gland	PG16
listwa zaciskowa terminal	10 mm ²

OKABLOWANIE
Sockets wiring

16A/5p	2.5mm ² H07V-K /LgY/ 450/750V
230V	1.5mm ² H07V-K /LgY/ 450/750V

F3.1869 Roz. RS-KOMBI 16/5, 4x230V
Distribution box RS-KOMBI 16/5, 4x230V

F-ELEKTRO
www.f-elektro.com,
e-mail: info@f-elektro.com