

wymiary w [mm]
dimensions [mm]

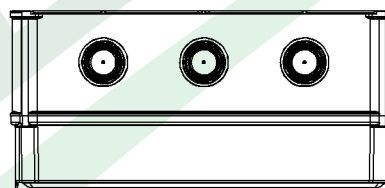
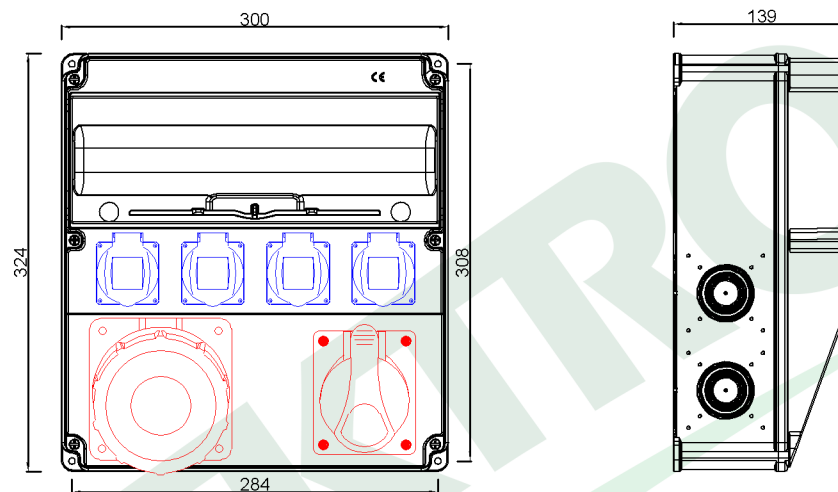

PARAMETRY PARAMETERS	
obudowa box	IP66
gniazda sockets	IP44
zaciski terminal	N & PE
dławica cable gland	PG21
OKABLOWANIE GNIAZD Sockets wiring	
63A/5p	10mm ² H07V-K /LgY/ 450/750V
32A/5p	4mm ² H07V-K /LgY/ 450/750V
230V	1.5mm ² H07V-K /LgY/ 450/750V

F3.2880 Roz. CAJA 15M 32/5, 63/5, 4x230V IP44
Distribution box CAJA 15M 32/5, 63/5, 4x230V IP44

F-ELEKTRO
www.f-elektro.com,
e-mail: info@f-elektro.com