

PCE data sheet

article#	592-4v
article description	CEE-wall mounted plug 32A 2p 24/42VAC 100-200Hz IP44 TWIST
description long	CEE-wall mounted plug 32A 2p 24/42VAC 100-200Hz IP44 TWIST housing material: PA6 rated current: 32A number of poles: 2 (2P) clock-position: 4h rated voltage/frequency: 24/42V~ / 100-200Hz contacts: brass nickel plated connection technology: screw terminals IP protection class: IP44
GTIN (EAN)	9003399224409
country of origin	AT
customs number	85366990
net weight	0.182 kg
packaging quantity	10
minimum order quantity	10

ETIM 7.0	EC001319
IEC-amperage	32 A
Voltage acc. EN 60309-2	20-25 V / 40-50 V (100-200 Hz) green
Number of poles	2
Clock hour position	4 h
Identification colour	Green
Degree of protection (IP)	IP44
Connection system	Schraubklemme
Construction type	Surface mounted plug
Angle of plug	Angled
Material	Plastic

a	106 mm
wire flexible	4-10 mm ²
wire solid	4-10 mm ²
contact screws	110 Ncm
dismantling length	70 mm
stripping length	14-16 mm

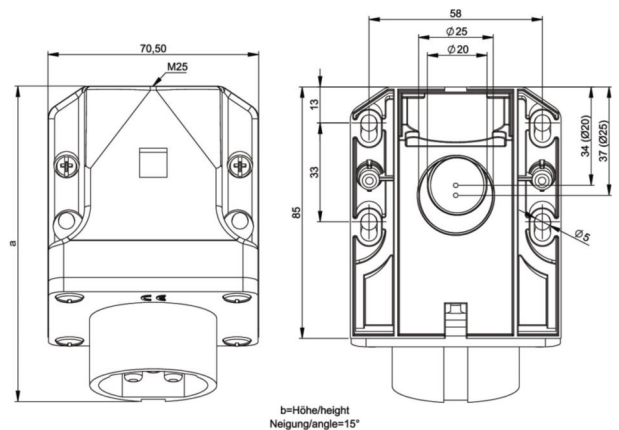

www.manufacturer-safety.info