

# R15 - 4 CO

## industrial relays of small dimensions

R15 - 4 CO

R15-...-K - 4 CO (AC)

R15-...-K - 4 CO (DC)

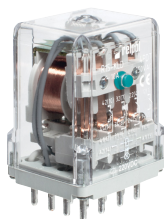
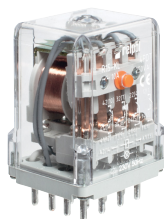
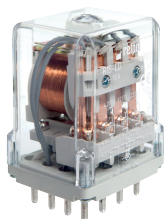

- General purpose relays, designed for continuous operation\*
- For plug-in sockets: on 35 mm rail mount acc. to EN 60715; on panel mounting; with terminals for soldering
- Coils AC and DC, insulation class F: 155 °C
- Recognitions, certifications, directives: RoHS,



### Contact data

Number and type of contacts		4 CO
Contact material		<b>AgSnO<sub>2</sub></b> , AgNi, AgNi/Au flash gold plating, AgNi/Au hard gold plating
Rated / max. switching voltage	AC	250 V / 440 V
Min. switching voltage		10 V AgSnO <sub>2</sub> , 10 V AgNi, 10 V AgNi/Au flash gold plating 5 V AgNi/Au hard gold plating
Rated load (capacity)	AC1 AC15 DC1 DC13	10 A / 250 V AC 3 A / 120 V                      1,5 A / 240 V (B300) 10 A / 24 V DC (see Fig. 3) 0,22 A / 120 V                      0,1 A / 250 V (R300)
Motor load	acc. to UL 508 AC3 acc. to IEC 60947-4-1	1/2 HP                      240 V AC, 4,9 FLA, single-phase motor ① 0,37 kW                      240 V AC, single-phase motor
Min. switching current		10 mA AgSnO <sub>2</sub> , 5 mA AgNi, 5 mA AgNi/Au flash gold plating 5 mA AgNi/Au hard gold plating
Max. make current		20 A
Rated current		10 A
Max. breaking capacity	AC1	2 500 VA
Min. breaking capacity		0,5 W AgSnO <sub>2</sub> , 0,3 W AgNi, 0,3 W AgNi/Au flash gold plating 0,05 W AgNi/Au hard gold plating
Contact resistance		≤ 100 mΩ
Max. operating frequency	• at rated load AC1 • no load	1 200 cycles/hour 12 000 cycles/hour

### Coil data

Rated voltage	50 Hz AC 60 Hz AC DC	6, 12, 24, 48, 60, 110, 115, 120, 127, 220, 230, 240, 400 V basic version 6, 12, 24, 48, 60, 110, 120, 220, 230, 240 V special version 6, <b>12, 24</b> , 48, 60, 110, 120, <b>220</b> V
Must release voltage		AC: ≥ 0,15 U <sub>n</sub> DC: ≥ 0,1 U <sub>n</sub>
Operating range of supply voltage		see Tables 1, 2, 3
Rated power consumption	AC DC	2,8 VA 1,5 W

### Insulation according to EN 60664-1

Insulation rated voltage		250 V AC
Rated surge voltage		2 500 V    1,2 / 50 μs
Overvoltage category		III
Insulation pollution degree		3
Dielectric strength	• between coil and contacts • contact clearance • pole - pole	2 500 V AC                      type of insulation: basic 1 500 V AC                      type of clearance: micro-disconnection 2 000 V AC                      type of insulation: basic
Contact - coil distance	• clearance • creepage	≥ 3 mm ≥ 3,2 mm

### General data

Operating / release time (typical values)		AC: 12 ms / 10 ms                      DC: 18 ms / 7 ms
Electrical life	• resistive AC1 • cosφ	≥ 10 <sup>5</sup> 10 A, 250 V AC see Fig. 2
Mechanical life (cycles)		≥ 2 x 10 <sup>7</sup>
Dimensions (L x W x H) / Weight		35 x 42,5 x 54,5 mm / 95 g
Ambient temperature	• storage (non-condensation and/or icing)	-40...+85 °C
	• operating	coil AC: -40...+55 °C                      coil DC: -40...+70 °C
Cover protection category		IP 20 (with socket GZ14U, GZ14)    EN 60529
Environmental protection		RTI                      EN 61810-1
Shock resistance		10 g
Vibration resistance		5 g 10...150 Hz
Solder temperature / Soldering time		max. 350 °C / max. 5 s

The data in bold type relate to the standard versions of the relays. \*The relays are designed for continuous operation while maintaining the parameters declared in the data sheet. ① For single phase motors for 110-120 V AC do not use motors with higher FLA than given for 240 V AC.

# R15 - 4 CO

industrial relays of small dimensions

**Electrical life at AC resistive load.**  
Switching frequency: 1 200 cycles/hour Fig. 1

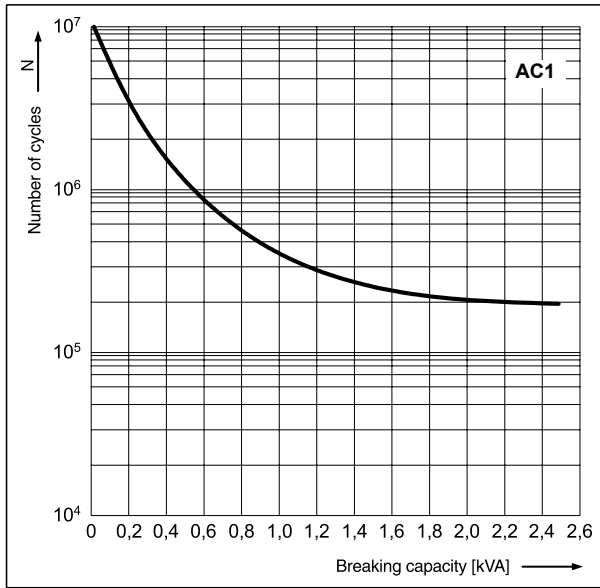

**Electrical life reduction factor at AC inductive load** Fig. 2

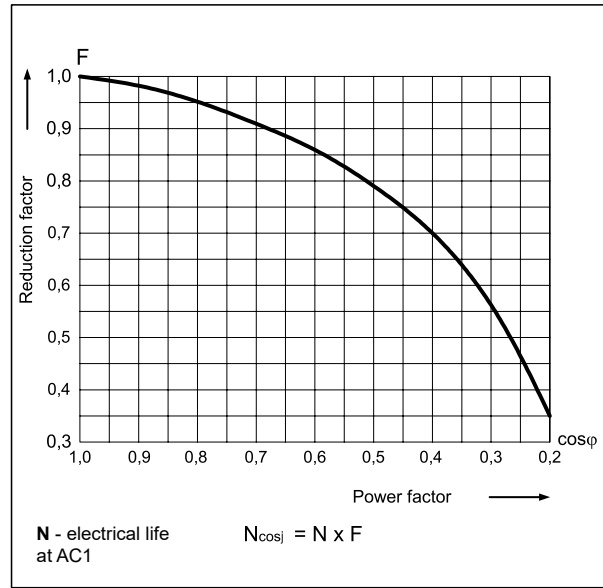

**Max. DC breaking capacity**  
A - resistive load DC1  
B - inductive load L/R = 40 ms Fig. 3

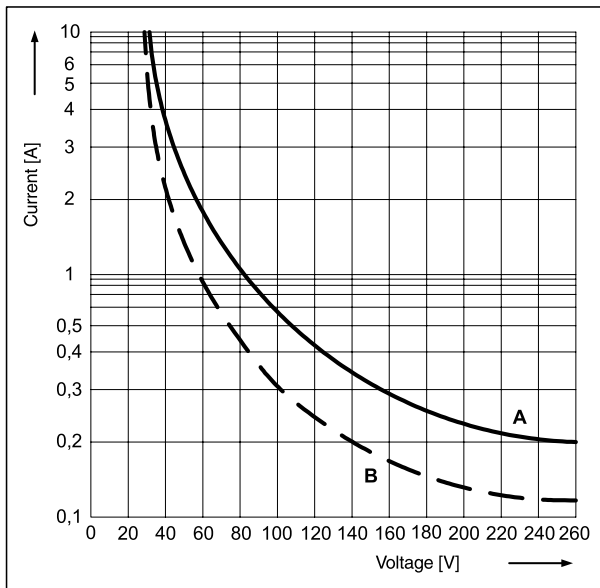

**Connection diagram (pin side view)**

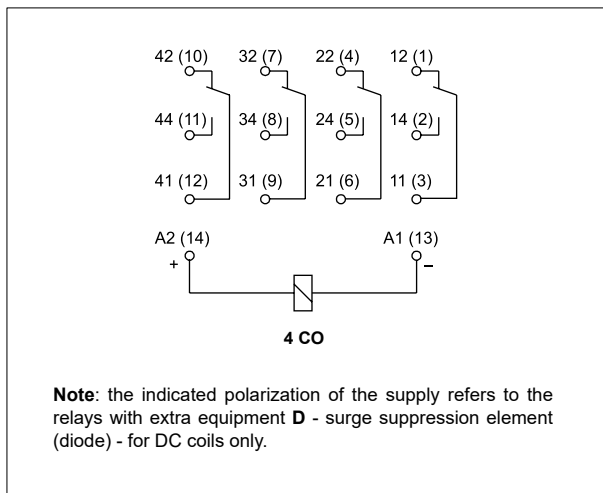

**Note:** the indicated polarization of the supply refers to the relays with extra equipment **D** - surge suppression element (diode) - for DC coils only.

**Dimensions**

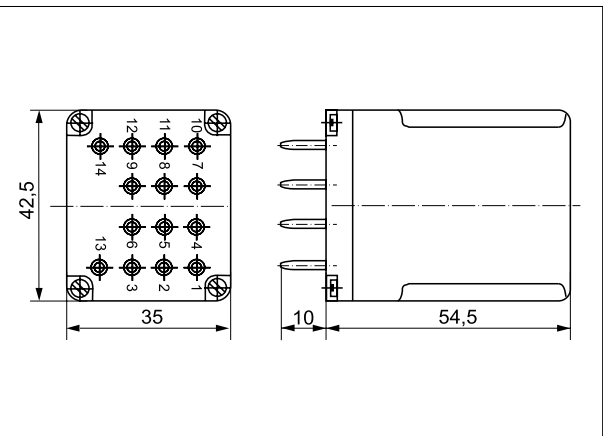

## GZ14P

Push-in terminals  
plug-in sockets  
for R15 - 4 CO  
for connection  
behind panel mounting  
- see page 6

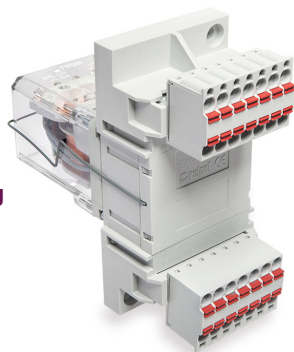

# R15 - 4 CO

## industrial relays of small dimensions

### Contact material selection for different load types

- **AgSnO<sub>2</sub>** - for DC and AC current loads (good resistance to inrush currents), for inductive loads.
- **AgNi** - for AC and DC current loads (good resistance when disconnecting the electric arc), for resistive and slightly inductive loads,
- **AgNi/Au flash gold plating** - Au protects the contact surface during storage,
- **AgNi/Au hard gold plating** - for small resistive loads in control circuits.

### Coil data - DC voltage version

Table 1

Coil code	Rated voltage V DC	Coil resistance at 20 °C Ω	Acceptable resistance	Coil operating range V DC	
				min. (at 20 °C)	max. (at 70 °C)
1006	6	28	± 10%	5,1	6,6
<b>1012</b>	<b>12</b>	<b>110</b>	<b>± 10%</b>	<b>10,2</b>	<b>13,2</b>
<b>1024</b>	<b>24</b>	<b>430</b>	<b>± 10%</b>	<b>20,4</b>	<b>26,4</b>
1048	48	1 750	± 10%	40,8	52,8
1060	60	2 700	± 10%	51,0	66,0
1110	110	9 200	± 10%	93,5	121,0
1120	120	11 000	± 10%	102,0	132,0
<b>1220</b>	<b>220</b>	<b>37 000</b>	<b>± 10%</b>	<b>187,0</b>	<b>242,0</b>

The data in bold type relate to the standard versions of the relays.

### Coil data - AC 50 Hz voltage version, basic

Table 2

Coil code	Rated voltage V AC	Coil resistance at 20 °C Ω	Acceptable resistance	Coil operating range V AC	
				min. (at 20 °C)	max. (at 55 °C)
3006	6	4,8	± 15%	5,10	6,6
3012	12	20	± 15%	10,20	13,2
3024	24	72	± 15%	20,40	26,4
3048	48	360	± 15%	40,80	52,8
3060	60	520	± 15%	51,00	66,0
3110	110	2 000	± 15%	93,50	121,0
3115	115	2 100	± 15%	97,70	126,5
3120	120	2 300	± 15%	102,00	132,0
3127	127	2 370	± 15%	107,95	139,7
3220	220	7 000	± 15%	187,00	242,0
3230	230	7 900	± 15%	195,50	253,0
3240	240	8 300	± 15%	204,00	264,0
3400	400	21 500	± 15%	340,00	440,0

### Coil data - AC 60 Hz voltage version, special

Table 3

Coil code	Rated voltage V AC	Coil resistance at 20 °C Ω	Acceptable resistance	Coil operating range V AC	
				min. (at 20 °C)	max. (at 55 °C)
6006	6	4,8	± 15%	5,1	6,6
6012	12	17	± 15%	10,2	13,2
6024	24	65	± 15%	20,4	26,4
6048	48	310	± 15%	40,8	52,8
6060	60	490	± 15%	51,0	66,0
6110	110	1 760	± 15%	93,5	121,0
6120	120	2 000	± 15%	102,0	132,0
6220	220	6 900	± 15%	187,0	242,0
6230	230	7 000	± 15%	195,5	253,0
6240	240	7 100	± 15%	204,0	264,0

# R15 - 4 CO

## industrial relays of small dimensions

### Mounting, sockets and accessories for relays

Relays **R15 4 - CO** are designed for mounting in plug-in sockets.

Sockets for R15 - 4 CO	Accessories	Additional equipment
	Spring wire clips	
<b>Screw terminals sockets, 35 mm rail mount (acc. to EN 60715)</b>		
GZ14U	GZ14 0737	–
<b>Screw terminals sockets, on panel mounting (two M3 screws)</b>		
GZ14	GZ14 0737	–
GZ14Z <sup>Ⓢ</sup>	GZ14 0737	–
<b>Push-in terminals sockets, on panel mounting (two M3 screws)</b>		
GZ14P <sup>Ⓢ</sup>	GZ14 0737	–
<b>Solder terminals sockets</b>		
GOP14	R15 0736	R15 5922 <sup>Ⓢ</sup>

<sup>Ⓢ</sup> Sockets GZ14Z, GZ14P: for connection behind panel mounting - see page 6. <sup>Ⓢ</sup> Spring clamps R15 5922.

### Ordering codes

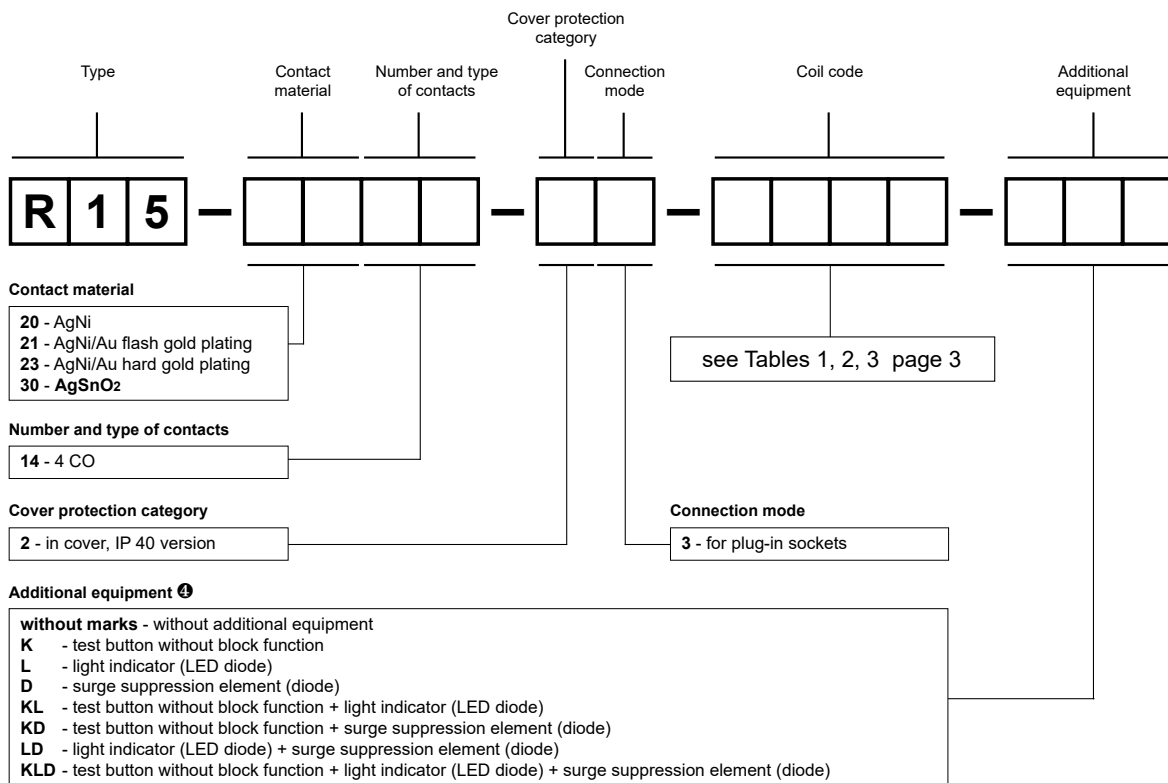

<sup>Ⓢ</sup> K - orange colour (AC coils), green (DC coils). D, KD, LD, KLD - available only in relays with DC coils.

#### Note:

For relays with additional equipment **D** - surge suppression element (diode) (versions D, KD, LD, KLD) - fixed supply polarization compulsory for the DC load of coils: -A1(13) / +A2(14). The polarization is indicated on the relay cover. For other versions of the relays with DC coils any polarization is possible.

Examples of ordering codes:

#### R15-2014-23-1024-KD

relay **R15**, for plug-in sockets, four changeover contacts, contact material AgNi, coil voltage 24 V DC, with test button without block function and surge suppression element (diode), in cover IP 40

#### R15-3014-23-3230

relay **R15**, for plug-in sockets, four changeover contacts, contact material AgSnO<sub>2</sub>, coil voltage 230 V AC 50 Hz, in cover IP 40

# Sockets and accessories

## GZ14U

For R15 - 4 CO

Screw terminals  
 Max. tightening moment  
 for the terminal: 0,7 Nm  
 35 mm rail mount  
 acc. to EN 60715  
 96,8 x 46,4 x 33,3 mm  
 Four poles  
 10 A, 250 V AC

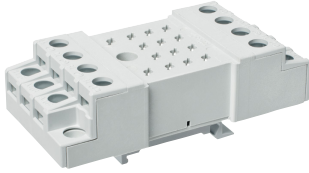

### Connection diagram

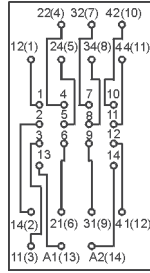

### Adaptor

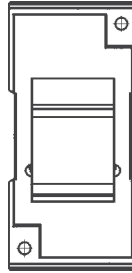

GZ14 0737

### Dimensions

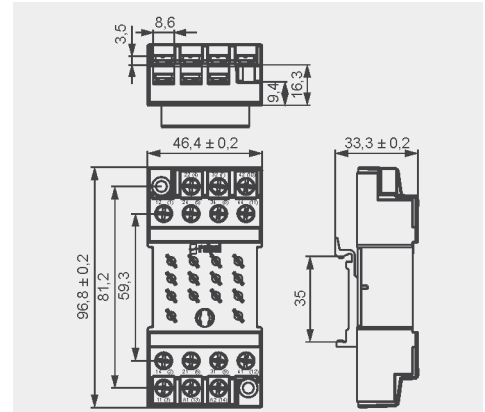

### Accessories

## GZ14

For R15 - 4 CO

Screw terminals  
 Max. tightening moment  
 for the terminal: 0,7 Nm  
 On panel mounting  
 96,8 x 46,4 x 24,5 mm  
 Four poles  
 10 A, 250 V AC



### Connection diagram

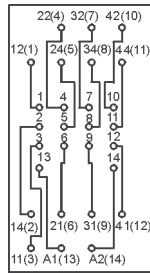

### Mounting dimensions



GZ14 0737

### Dimensions

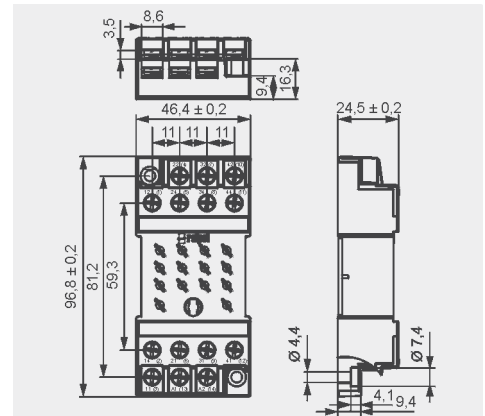

### Accessories

## GZ14U

Screw terminals  
 plug-in sockets  
 for R15 - 4 CO



### PRECAUTIONS:

1. Ensure that the parameters of the product described in its specification provide a safety margin for the appropriate operation of the device or system and never use the product in circumstances which exceed the parameters of the product. 2. Never touch any live parts of the device. 3. Ensure that the product has been connected correctly. An incorrect connection may cause malfunction, excessive heating, excessive heating or risk of fire. 4. In case of any risk of any serious material loss or death or injuries of humans or animals, the devices or systems shall be designed so to equip them with double safety system to guarantee their reliable operation.

# Sockets and accessories

## GZ14Z

For R15 - 4 CO

Screw terminals  
Max. tightening moment  
for the terminal: 0,7 Nm  
**On panel mounting, behind**  
92,2 x 46 x 24,5 mm  
Four poles  
10 A, 250 V AC



### Connection diagram

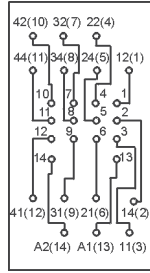

### Mounting dimensions

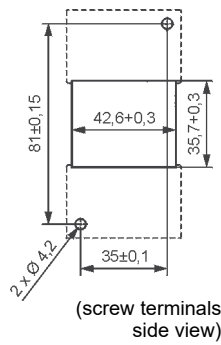

(screw terminals side view)



GZ14 0737

### Dimensions

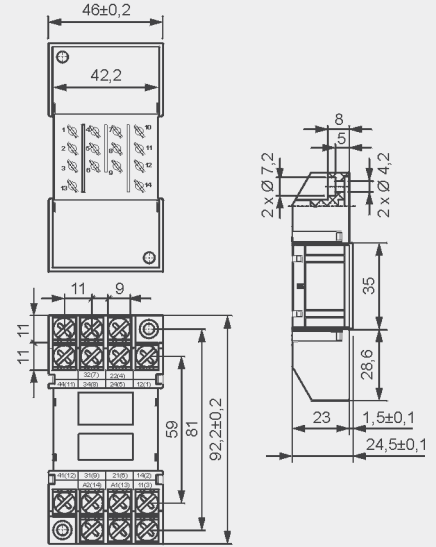

### Accessories

## GZ14P

For R15 - 4 CO

Push-in terminals  
Max. cross section of the cables:  
2 x 2,5 mm<sup>2</sup> (ferrules without insulation)  
2 x 1,5 mm<sup>2</sup> (ferrules with insulation)  
Stripping length: 10 mm

**On panel mounting, behind**  
92,2 x 46,2 x 44,7 mm  
Four poles  
10 A, 250 V AC

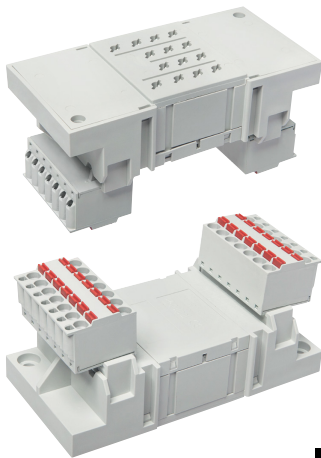

### Connection diagram

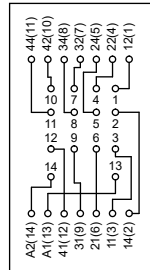

### Mounting dimensions

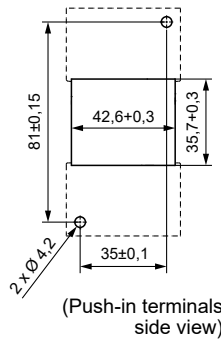

(Push-in terminals side view)



GZ14 0737

### Dimensions

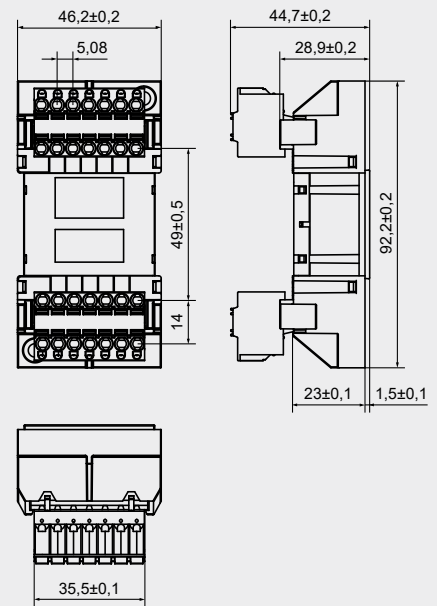

### Accessories

## GOP14

For R15 - 4 CO

Solder terminals  
50 x 42 x 23 mm  
Four poles  
10 A, 250 V AC

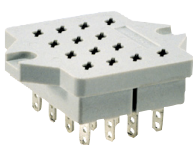

### Accessories



R15 0736



R15 5922

### Dimensions

