

## LG-V5 SET

support LG-V5  
(element mocujący LG-V5)

- (GB) Mounting instructions
- (DE) Montageanleitung
- (SI) Navodilo za montažo
- (PL) Instrukcje montażu
- (HR) Upute za montažu
- (CZ) Montážní návod
- (SK) Navod na montáž
- (HU) Szerelési utmutató
- (LT) Montavimo instrukcija
- (RU) Инструкция за монтаж
- (LV) Montažas instrukcija
- (EST) Paigaldusjuhend

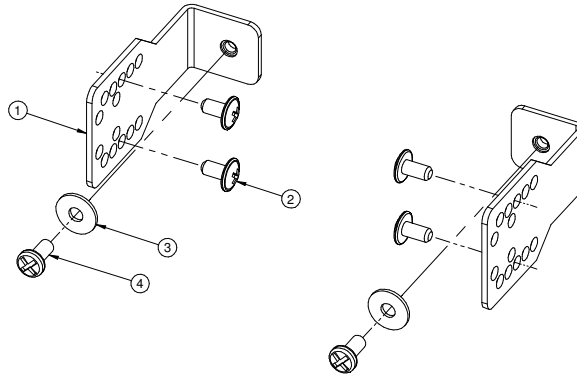

No.	Type ETI	Name	Pcs.
1	LG-V5	Support	2
2	AST 4.8x9.5	Tapping screw	4
3	AW-RE 5	Washer M5 DIN9021 Zn	2
4	AS-C 5x10	Screw M5x10 DIN7985 Zn	2

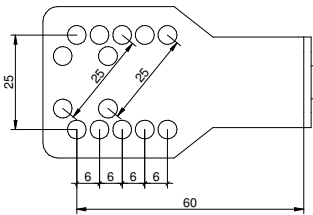

Position 1

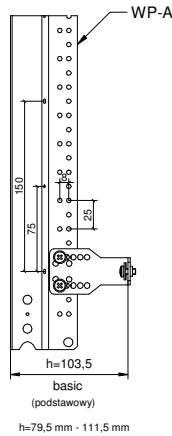

Position 2

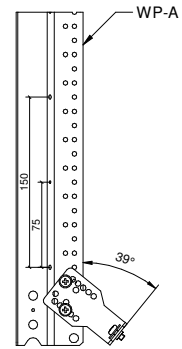

## LG-V5 SET

support LG-V5  
(element mocujący LG-V5)

- (GB) Mounting instructions
- (DE) Montageanleitung
- (SI) Navodilo za montažo
- (PL) Instrukcje montażu
- (HR) Upute za montažu
- (CZ) Montážní návod
- (SK) Navod na montáž
- (HU) Szerelési utmutató
- (LT) Montavimo instrukcija
- (RU) Инструкция за монтаж
- (LV) Montažas instrukcija
- (EST) Paigaldusjuhend

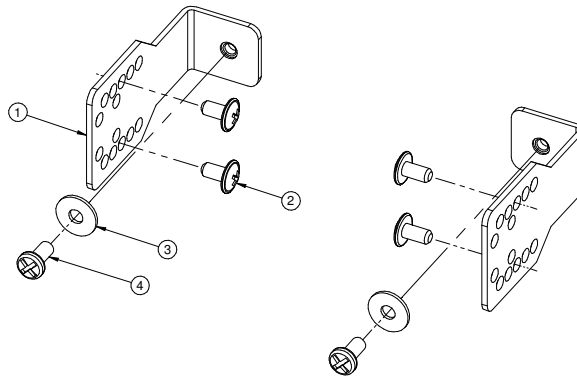

No.	Type ETI	Name	Pcs.
1	LG-V5	Support	2
2	AST 4.8x9.5	Tapping screw	4
3	AW-RE 5	Washer M5 DIN9021 Zn	2
4	AS-C 5x10	Screw M5x10 DIN7985 Zn	2

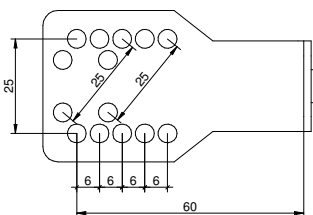

Position 1

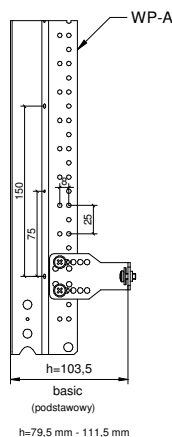

Position 2

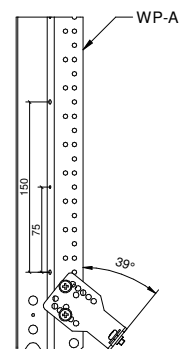

**LG-V5 SET**

support LG-V5  
(element mocujący LG-V5)

No.	Type ETI	Name	Pcs.
1	LG-V5	Support	2
2	AST 4.8x9.5	Tapping screw	4
3	AW-RE 5	Washer M5 DIN9021 Zn	2
4	AS-C 5x10	Screw M5x10 DIN7985 Zn	2

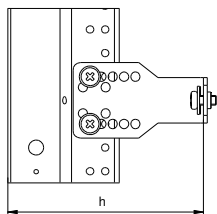

Position 1

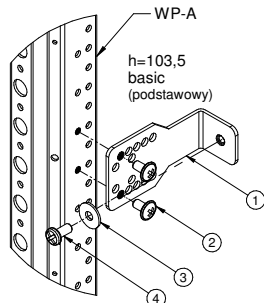

Position 2

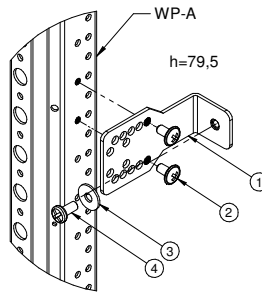

Position 3

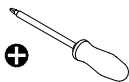
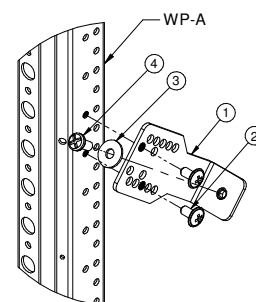

Screwdriver PH2  
(Wkrętak PH2)

AS-C 5x10	2,2-3,5 Nm
AST 4.8x9.5	3,0-3,4 Nm

**LG-V5 SET**

support LG-V5  
(element mocujący LG-V5)

No.	Type ETI	Name	Pcs.
1	LG-V5	Support	2
2	AST 4.8x9.5	Tapping screw	4
3	AW-RE 5	Washer M5 DIN9021 Zn	2
4	AS-C 5x10	Screw M5x10 DIN7985 Zn	2

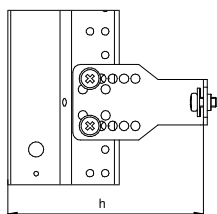

Position 1

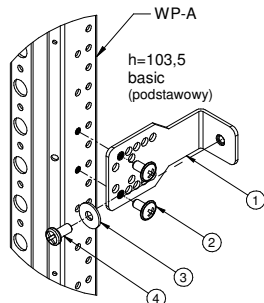

Position 2

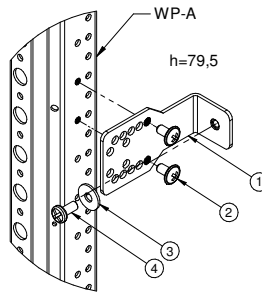

Position 3

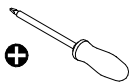
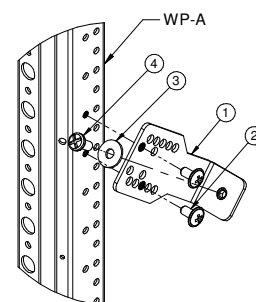

Screwdriver PH2  
(Wkrętak PH2)

AS-C 5x10	2,2-3,5 Nm
AST 4.8x9.5	3,0-3,4 Nm