

Maßskizze / dimensional drawing

Benennung: Motorschutzkontaktstecker 16A 230V 3,0 - 8,0A

description: Motor protection plugs 16A 230V 3,0 - 8,0A

Teilenummer / part number: 5610*

PCE

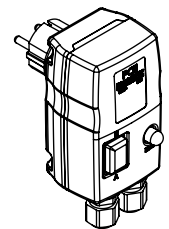
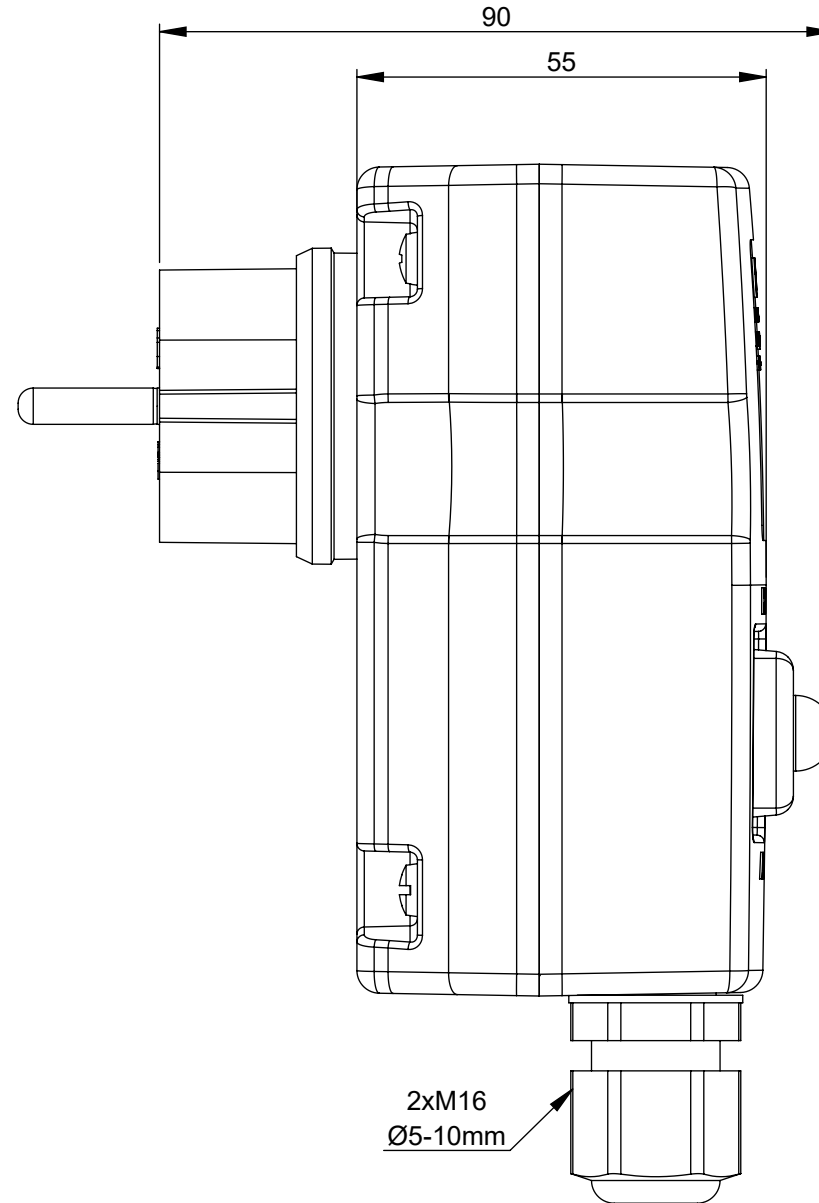
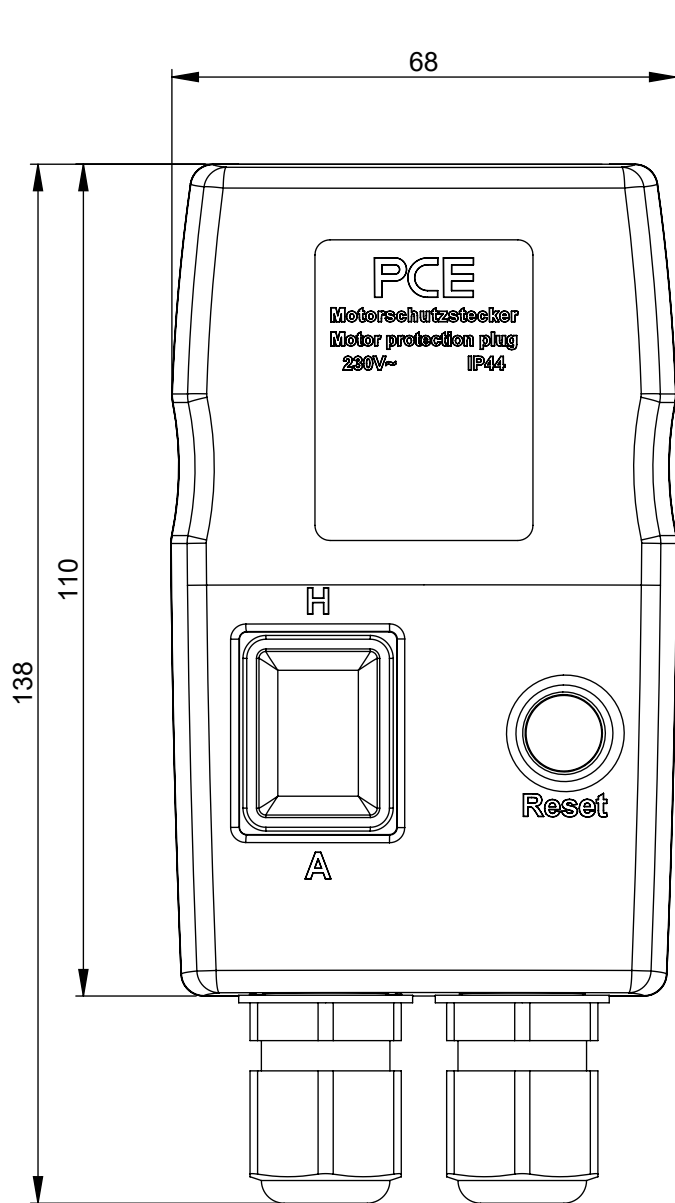

M1:5