

Reference(s) :

- from 4 220 56 to 4 220 95;
- from 4 220 96 to 4 221 35;
- from 4 221 36 to 4 221 75;
- from 4 221 76 to 4 222 15;
- from 4 224 98 to 4 225 37;

DPX³ 630 electronic circuit breakers



CONTENTS

PAGES

1. USE	1
2. RANGE	1
3. DIMENSIONS AND WEIGHTS	1
4. OVERVIEW	2
5. ELECTRICAL CONNECTIONS	2
6. ELECTR. AND MECH. CHARACTERISTIC	4
7. ELECTRONIC PROTECTION UNIT	6
8. CONFORMITY	8
9. EQUIPMENTS AND ACCESSORIES	9
10. CURVES	12

1. USE

DPX³ platform, for premium segment, is able to cover extended ranges in terms of breaking capacities and rated currents, make protection suitable for different levels of power involved in installations.

DPX³ platform provide easy assembly procedures during the phase of installation and mounting of accessories, suitable for professional use.

2. RANGE

I _n (A)	S1		S2		S2 + measure		Sg		Sg + measure	
	3P	4P	3P	4P	3P	4P	3P	4P	3P	4P
250	422498	422503	422056	422061	422096	422101	422136	422141	422176	422181
320	422499	422504	422057	422062	422097	422102	422137	422142	422177	422182
400	422500	422505	422058	422063	422098	422103	422138	422143	422178	422183
500	422501	422506	422059	422064	422099	422104	422139	422144	422179	422184
630	422502	422507	422060	422065	422100	422105	422140	422145	422180	422185
	50kA		50kA		50kA		50kA		50kA	
250	422508	422513	422066	422071	422106	422111	422146	422151	422186	422191
320	422509	422514	422067	422072	422107	422112	422147	422152	422187	422192
400	422510	422515	422068	422073	422108	422113	422148	422153	422188	422193
500	422511	422516	422069	422074	422109	422114	422149	422154	422189	422194
630	422512	422517	422070	422075	422110	422115	422150	422155	422190	422195
	70kA		70kA		70kA		70kA		70kA	
250	422518	422523	422076	422081	422116	422121	422156	422161	422196	422201
320	422519	422524	422077	422082	422117	422122	422157	422162	422197	422202
400	422520	422525	422078	422083	422118	422123	422158	422163	422198	422203
500	422521	422526	422079	422084	422119	422124	422159	422164	422199	422204
630	422522	422527	422080	422085	422120	422125	422160	422165	422200	422205
	100kA		100kA		100kA		100kA		100kA	
250	422528	422533	422086	422091	422126	422131	422166	422171	422206	422211
320	422529	422534	422087	422092	422127	422132	422167	422172	422207	422212
400	422530	422535	422088	422093	422128	422133	422168	422173	422208	422213
500	422531	422536	422089	422094	422129	422134	422169	422174	422209	422214
630	422532	422537	422090	422095	422130	422135	422170	422175	422210	422215

3. DIMENSIONS AND WEIGHTS

3.1 Dimensions

Implantation

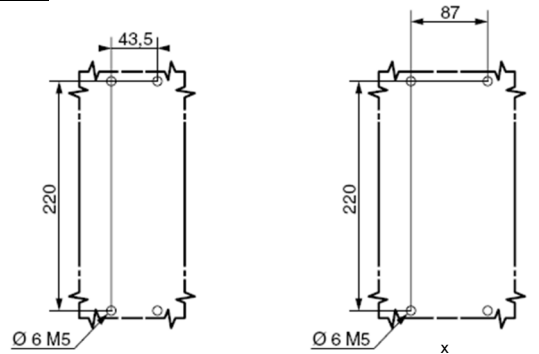

Fixed version, with front terminals

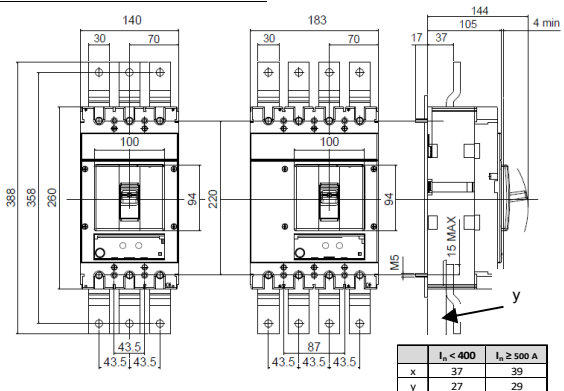

Fixed version, with flat rear terminal

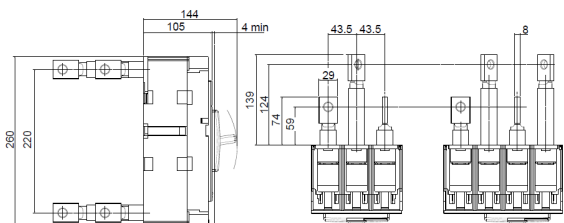

DPX³ 630 electronic circuit breakers

Reference(s) :

from 4 220 56 to 4 220 95;

from 4 220 96 to 4 221 35;

from 4 221 36 to 4 221 75;

from 4 221 76 to 4 222 15;

from 4 224 98 to 4 225 37;

Plug-in version, with cage terminals

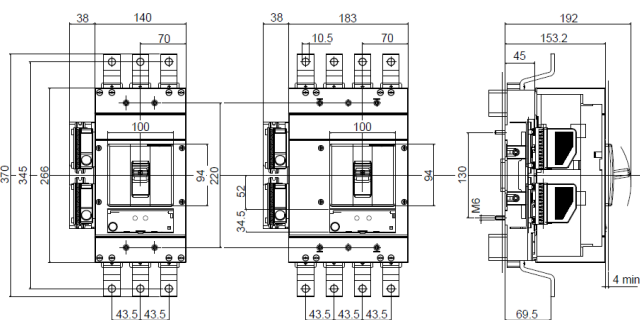

Plug-in version, without front terminals

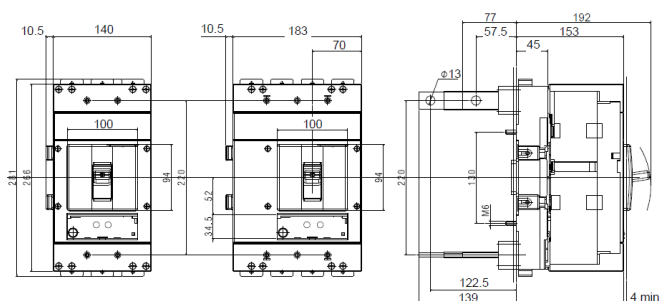

Draw-out version, flat rear terminals

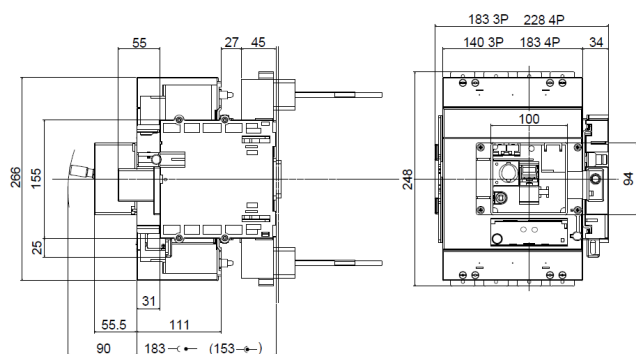

Draw-out version with sliding auxiliary contacts

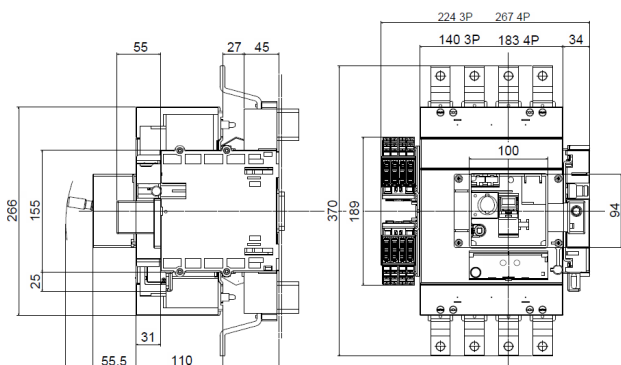

Motor operator for synchronized operations (energy storage type)

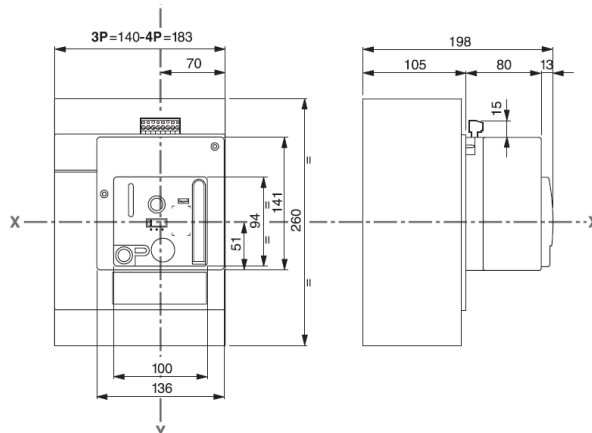

Motor operator for general purpose operations (direct action type)

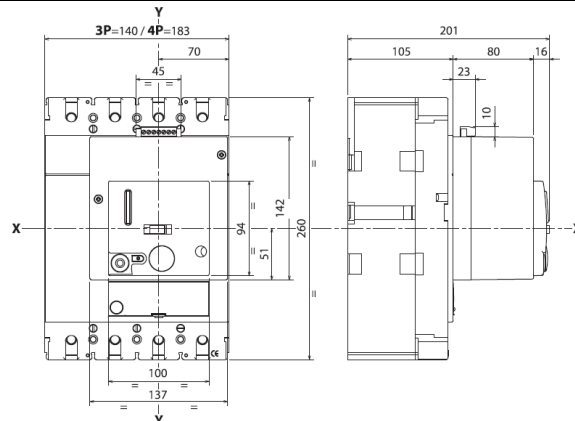

3.2 Weights

Configuration	Weights (Kg)			
	3P		4P	
	$I_n \leq 400A$	$I_n \geq 500A$	$I_n \leq 400A$	$I_n \geq 500A$
Circuit breaker (fixed version)	5.80	6.20	7.30	7.80
Plug-in (with front terminals)*	3.35	3.35	4.29	4.29
Plug-in (with rear terminals)*	3.55	3.55	4.79	4.79
Draw-out *	2.3	2.3	5.5	5.5

* to add to fixed version

4. OVERVIEW

4.1 Supplied with:

- fixing screws (4 for 3P and 4P)
- screws for connections (6 for 3P and 8 for 4P)
- phase insulators (2 for 3P and 3 for 4P)

5. ELECTRICAL CONNECTIONS

5.1 Mounting possibilities

On plate:

- Vertical
- Horizontal
- Supply inverter type

DPX³ 630 electronic circuit breakers

Reference(s) :
 from 4 220 56 to 4 220 95;
 from 4 220 96 to 4 221 35;
 from 4 221 36 to 4 221 75;
 from 4 221 76 to 4 222 15;
 from 4 224 98 to 4 225 37;

5.2 Mounting

(see instruction sheet for detailed mounting procedures)

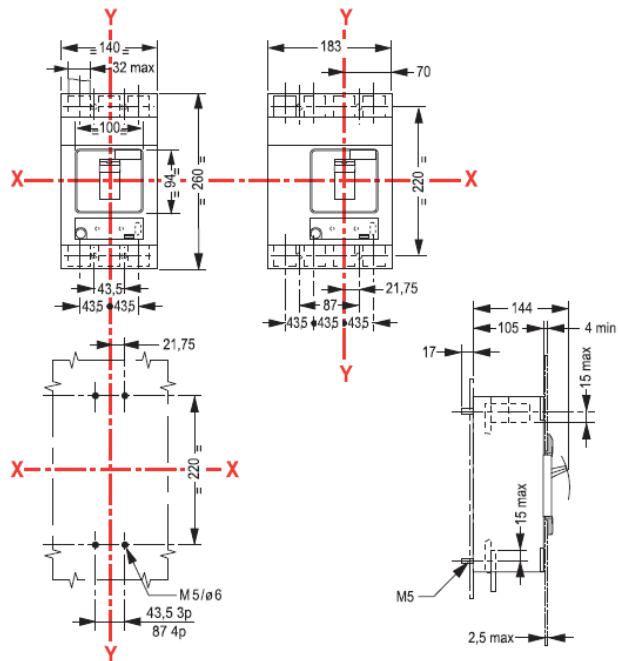

Busbars/cable lugs:

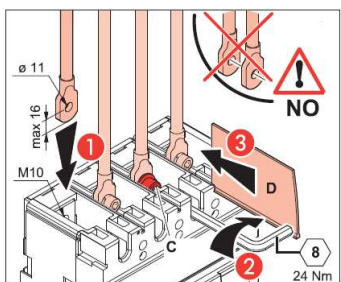
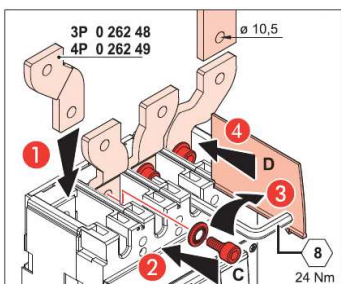
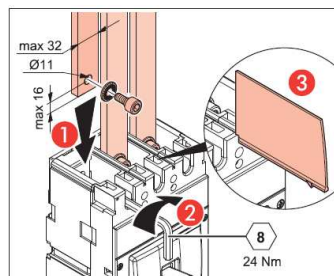

Cables:

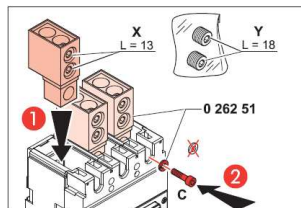
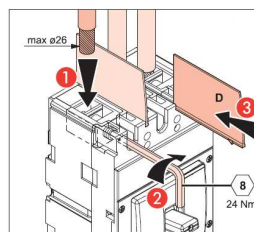
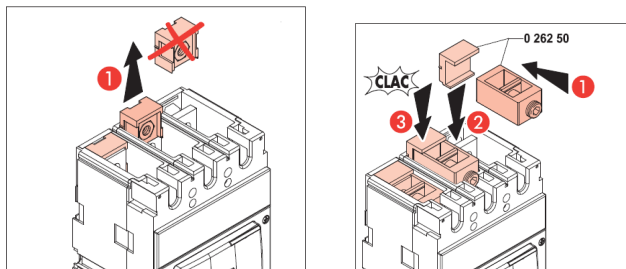

	X (L=13)	Y (L=18)
Flexible Conductors	120+185 mm ²	50+95 mm ²
Rigid Conductors	150+240 mm ²	70+120 mm ²

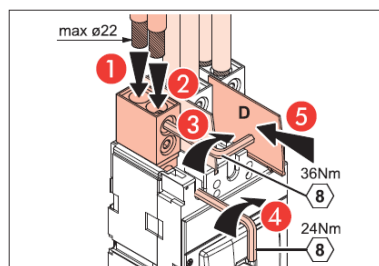

DPX³ 630 electronic circuit breakers

Reference(s) :
 from 4 220 56 to 4 220 95;
 from 4 220 96 to 4 221 35;
 from 4 221 36 to 4 221 75;
 from 4 221 76 to 4 222 15;
 from 4 224 98 to 4 225 37;

6. ELECTRICAL AND MECHANICAL CHARACTERISTICS

Circuit breaker

Circuit Breaker	DPX ³ 630 F/N/H/L (36kA, 50kA, 70kA, 100kA)
Rated current (A)	250, 320, 400, 500, 630
Poles	3 - 4
Pole pitch (mm)	42
Rated insulation voltage (50/60Hz) U _i (V)	800
Rated operating voltage (50/60Hz) U _o (V)	690
Rated impulse withstand current U _{imp}	8
Rated frequency (Hz)	50 - 60
Operating temperature (°C)	-25 ÷ 70
Mechanical endurance (cycles)	20000
Mechanical endurance with motor control	10000
Electrical endurance at I _n (cycles)	4000
Electrical endurance at 0.5 I _n (cycles)	8000
Utilization category	B (I _n ≤ 400A); A (I _n ≥ 500A)
Suitable for isolation	Yes
Type of protection	Electronic
Electronic trip S1	Yes
Electronic trip S2	Yes
Electronic trip Sg	Yes
Thermal adjustment I _t	(0.4 ÷ 1) × I _n
Magnetic adjustment I _{ed} (A)	(1.5 ÷ 10) × I _t
Neutral protection for 4P (%I _{th} of phase pole)	0 - 50 - 100 - 150 - 200
Dimensions (W x H x D) (mm)	140 x 260 x 105 (3P) 183 x 260 x 105 (4P)
Maximum weight for fixed version (kg)	6.20 (3P) 7.80 (4P)

The maximum admissible (absolute) temperature is 125°C
 (for detail, see IEC 60947-1 and 60947-2)

DPX³ product line has the possibility to supply both in "direct"
 and "reverse" feed.

If "direct", the word "LINE" needs to be marked on supply
 terminals (normally the top ones), as well as "LOAD" has to
 be written on the output terminals to be connected to the load
 (normally the bottom ones).

If "reverse", any indications about LINE / LOAD are NOT
 expected on the product.

6.1 Main parts constituting the circuit breaker

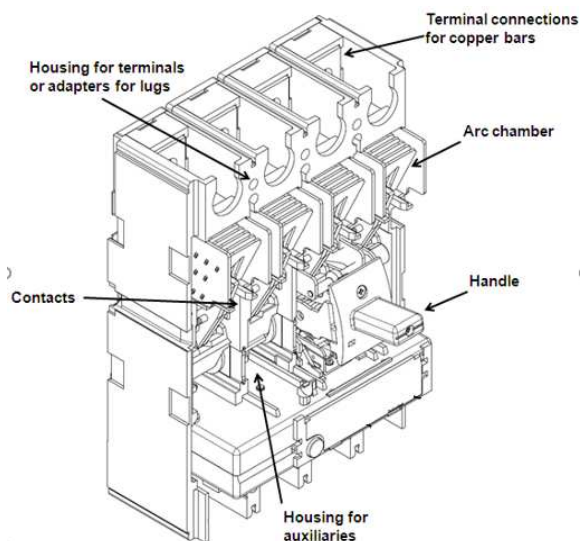

6.2 Breaking capacity (kA)

	U _e /I _{cu} (I _{cu} letter)	Breaking capacity (kA) & I _{cs}			
		3P-4P			
IEC 60947-2	220/240 V AC	70	100	105	150
	380/415 V AC	36	50	70	100
	440/460 V AC	30	40	60	70
	480/500 V AC	25	30	40	50
	480/550 V AC	20	22	25	28
	600 V AC	20	22	25	28
	690V AC	14	18	20	22
	I _{cs} (% I _{cu})	100	100	100	70
Rated making capacity under short circuit I _{cm}					
	I _{cm} (kA) at 415V	76.5	105	154	220
NEMA AB-1	220/240 V AC	70	100	105	150
	480/500 V AC	25	30	40	50
	690 V AC	14	18	20	22

6.3 Rated current (I_n) at 40°C / 50°C

I _n (A)	Phases limit trip current			
	thermal (I _t)		magnetic (I _l)	
	0.4 × I _n	1 × I _n	1.5 × I _t	10 × I _t
250	100	250	375	2500
320	128	320	480	3200
400	160	400	600	4000
500	200	500	750	5000
630	252	630	945	6300

* For neutral adjustment, as explained in technical sheet, please consider the values ratios 100% on set currents.

6.3 Load operations

Force on handle	I _n ≤ 400A	I _n ≥ 500A
Opening operation (N)	80	130
Closing operation (N)	180	210
Restore operation (N)	145	200

DPX³ 630 electronic circuit breakers

Reference(s) :
 from 4 220 56 to 4 220 95;
 from 4 220 96 to 4 221 35;
 from 4 221 36 to 4 221 75;
 from 4 221 76 to 4 222 15;
 from 4 224 98 to 4 225 37;

6.4 Electrodynamic forces

The table below shows an indication of suggested distances to keep between the breaker and the first fixing point of the conductor and bars in order to reduce the effects of the electrodynamic stresses that may be created during a short circuit. In the realization of anchorage system it is recommend the use of isolators suitable for the type of conductor used and the operating voltage.

I _{cc} (kA)	Maximum Distance (mm)
36	350
50	300
70	250
100	200

According to conductor type and bar system (except Legrand bar kits), the choice of the distance to keep is to be calibrated by the installer. Also installer must take into account the weight of the conductors so that this does not affect the electrical junction between the conductor itself and the connection point.

6.5 Power losses per pole under I_n

	Power losses per pole (W)									
	I _n (A)									
	250		320		400		500		630	
	Phase	Neutral	Phase	Neutral	Phase	Neutral	Phase	Neutral	Phase	Neutral
Cage terminals	7.5	7.5	12.3	12.3	19.2	19.2	22.1	22.1	35.0	35.0
Lugs	7.5	7.5	12.3	12.3	19.2	19.2	22.1	22.1	35.0	35.0
External lugs	8.2	8.2	13.5	13.5	21.1	21.1	25.1	25.1	39.8	39.8
Spreaders	9.0	9.0	14.7	14.7	22.9	22.9	26.7	26.7	42.3	42.3
Rear terminals	8.7	8.7	14.2	14.2	22.3	22.3	26.9	26.9	42.7	42.7
Plugin version	15.0	15.0	24.7	24.7	38.5	38.5	52.3	52.3	83.0	83.0
Circuit breaker + RCD	10.6	10.6	17.4	17.4	27.2	27.2	34.6	34.6	54.9	54.9

Note: power loss in the table above are referred and measured as described in the standard IEC 60947-2 (Annex G) for circuit-breakers. Values in the table are referred to a single phase.

6.6 DERATINGS

6.6.1 Temperature

Rated current and his adjustment has to be considered relating to a rise or fall of ambient temperature and to a different version or installation conditions. The table below indicates the maximum long-time (LT) protection setting depending on the ambient temperature.

I _n (A)	Temperature Ta (°C)		
	up to 50	60	70
250	250	250	250
320	320	320	320
400	400	360	340
500	500	500	500
630	630	567	536

For derating temperature with other configurations, see table A.

6.6.2 Specific condition use

Climatic conditions

according to IEC/EN 60947-1 Annex Q, Cat. F subject to temperature, humidity, vibration, shock and salt mist.

Electromagnetic disturbances (EMC)

for DPX³ 630 circuit breakers, according to IEC/EN 60947-2 Annex F

Pollution degree

for DPX³ 630 circuit breakers, degree 3, according to IEC/EN 60947-2

6.6.3 Altitude

Altitude derating for DPX³ and DPX³-I

Altitude (m)	2000	3000	4000	5000
U _e (V)	690	590	520	460
I _n (A) (T _a = 40°C/50°C)	1 x I _n	0.98 x I _n	0.93 x I _n	0.9 x I _n

DPX³ 630 electronic circuit breakers

Reference(s) :

- from 4 220 56 to 4 220 95;
- from 4 220 96 to 4 221 35;
- from 4 221 36 to 4 221 75;
- from 4 221 76 to 4 222 15;
- from 4 224 98 to 4 225 37;

7. ELECTRONIC PROTECTION UNIT

7.1 Version S1 – Adjustment of I_r , I_{sd}

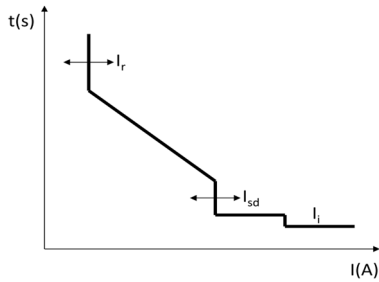
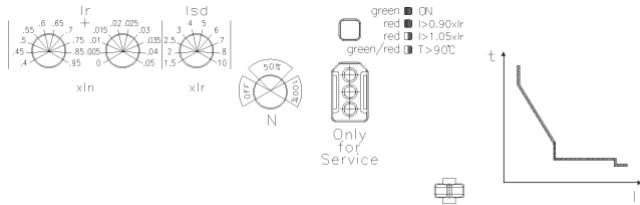

Long delay protection against overloads with an adjustable threshold bases on the RMS value of the current:

- $I_r = 0.4 \div 1 I_n$ (steps 1A)

Short delay protection against short-circuits with an adjustable I_{sd} threshold:

- $I_{sd} = 1.5 - 2 - 2.5 - 3 - 4 - 5 - 6 - 7 - 8 - 9 - 10 \times I_r$ (11 steps)

Instantaneous protection with fixed threshold:

- 500A $I_i = 15\text{kA}$,
- 630,800A $I_i = 15\text{kA}$,
- 1000A $I_i = 15\text{kA}$,
- 1250A $I_i = 15\text{kA}$,
- 1600A $I_i = 20\text{kA}$

7.2 Version S2 - Adjustment of I_r , T_r , I_{sd} , T_{sd}

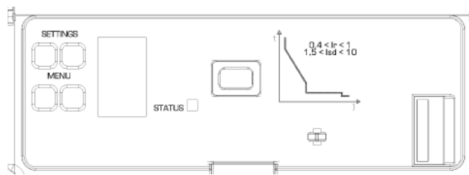

LCD display with adjustment buttons, battery case and USB port.

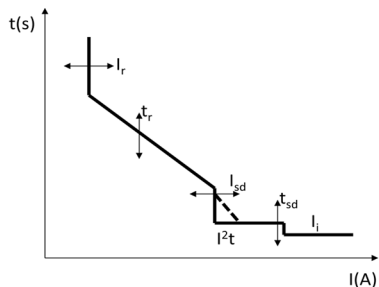

Long delay protection against overloads with an adjustable threshold bases on the RMS value of the current:

- $I_r = 0.4 \div 1 I_n$ (steps 1A)
- $T_r = 3 - 30\text{s}$ (3 - 5 - 10 - 15 - 20 - 25 - 30) (7 steps)

Short delay protection against short-circuits with an adjustable I_{sd} threshold:

- $I_{sd} = 1.5 - 2 - 2.5 - 3 - 4 - 5 - 6 - 7 - 8 - 9 - 10 \times I_r$ (11 steps)
- $T_{sd} = 0 - 100 - 200 - 300 - 400 - 500 \text{ ms}$ ($I = K$)
- $T_{sd} = 0 - 100 - 200 - 300 - 400 - 500 \text{ ms}$ ($I^2t = K$)

Instantaneous protection with fixed threshold:

- 500A $I_i = 15\text{kA}$,
- 630,800A $I_i = 15\text{kA}$,
- 1000A $I_i = 15\text{kA}$,
- 1250A $I_i = 15\text{kA}$,
- 1600A $I_i = 20\text{kA}$

7.3 Version Sg - Adjustment of I_r , T_r , I_{sd} , T_{sd} , I_g , T_g

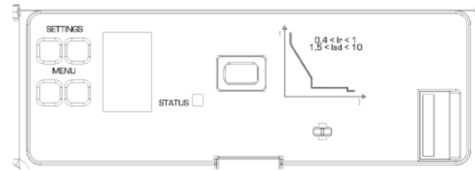

LCD display with adjustment buttons, battery case and USB port.

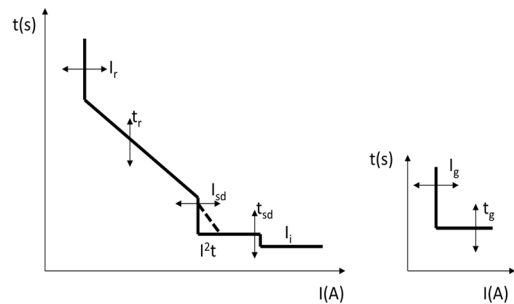

Long delay protection against overloads with an adjustable threshold bases on the RMS value of the current:

- $I_r = 0.4 \div 1 I_n$ (steps 1A)
- $T_r = 3 - 30\text{s}$ (3 - 5 - 10 - 15 - 20 - 25 - 30) (7 steps)

Short delay protection against short-circuits with an adjustable I_{sd} threshold :

- $I_{sd} = 1.5 - 2 - 2.5 - 3 - 4 - 5 - 6 - 7 - 8 - 9 - 10 \times I_r$ (11 steps)
- $T_{sd} = 0 - 100 - 200 - 300 - 400 - 500 \text{ ms}$ ($I = K$)
- $T_{sd} = 0 - 100 - 200 - 300 - 400 - 500 \text{ ms}$ ($I^2t = K$)

Instantaneous protection with fixed threshold:

- 500A $I_i = 15\text{kA}$,
- 630,800A $I_i = 15\text{kA}$,
- 1000A $I_i = 15\text{kA}$,
- 1250A $I_i = 15\text{kA}$,
- 1600A $I_i = 20\text{kA}$

Measure of ground fault:

- $I_g : 0.2 - 0.3 - 0.4 - 0.5 - 0.6 - 0.7 - 0.8 - 0.9 - 1 \times I_n$ (9 steps) and OFF
- $T_g : 0.1 - 0.2 - 0.3 - 0.4 - 0.5 - 1 \text{ s}$

DPX³ 630 electronic circuit breakers

Reference(s) :
 from 4 220 56 to 4 220 95;
 from 4 220 96 to 4 221 35;
 from 4 221 36 to 4 221 75;
 from 4 221 76 to 4 222 15;
 from 4 224 98 to 4 225 37;

Together with above protections, activated in case of electric faults, the trip unit also integrates self-protection for:

- Over temperature : in case the internal temperature of protection unit exceed 95°C;
- Auto diagnostics: in case embedded watchdog circuit detects internal malfunctions, which could compromise the correct working of microcontroller.

General remarks on protection unit

The protection units S1/S2/Sg are normally supplied by the internal current transformers (CTs).

When the current flowing through the circuit breaker is greater than 12% of the maximum power (20% of I_n for single phase load), the internal current supply ensures all operation of the protection unit, included LED status, display indications(*) and diagnostic functions (e.g. trip test).

(*)Display backlight and integrated measure (if available) are instead guaranteed starting from 20% of the maximum power (35% of I_n for single phase load), in absence of any other supply. In any case the external power supply is strongly recommended for the correct working of measurement, as well as RS485 communication.

For version S2/Sg, to ensure the same performance when the load is less than 12% of the maximum power (20% of I_n for single phase load) to grant complete functions, one of the following optional power supplies can be used:

- (*)external Auxiliary power supplier or, alternatively, Modbus communication interface.
- (*)power supply temporarily connected to frontal USB socket, connected to a 5V DC power bank or PC.

(*) available only for S2/Sg versions

In the electronic unit protection type S2/Sg, an energy metering central unit, if available, is integrated.

The possible parameters that can be measured are listed in the following table:

Measured	UNIT	DESCRIPTION
I_1	A	L1 realtime measured value
I_2	A	L2 realtime measured value
I_3	A	L3 realtime measured value
I_N (4P)	A	N realtime measured value
I_G	A	G realtime measured value
$U_{12} U_{23} U_{31}$ (3P)	V	Phase to Phase Voltage
$V_{12} V_{23} V_{31}$ (4P)	V	Voltage
Freq.	Hz	Frequency
P_{Tot}	kW	Active Power
Q_{Tot}	kvar	Reactive Power
PF		Power Factor
$E_p \downarrow$	kWh	Consumed active energy
$E_p \uparrow$	kWh	Returned active energy
$E_q \downarrow$	kvar h	Consumed reactive energy
$E_q \uparrow$	kvar h	Returned reactive energy
THDU ₁₂ /THDU ₂₃ /THDU ₃₁ (3P)	%	Chained Voltage THD
THDV _{1N} /THDV _{2N} /THDV _{3N} (4P)	%	Voltage THD
THDI ₁ /THDI ₂ /THDI ₃ /THDI _N	%	Current THD
MEM	A - °C	Cause of the last intervention and its value

Function performance class according to IEC 61557-12

Function symbol	Performance class	Measurement range					Other complementary characteristics				
		DPX ³ 630A					I_{max} PMD				
I_n		250A	320A	400A	500A	630A	250A	320A	400A	500A	630A
P	2	0.3kW	0.3kW	0.3kW	0.3kW	0.3kW	300A	380A	480A	600A	750A
QA, Qv	2	0.6kvar	0.6kvar	0.6kvar	0.6kvar	0.6kvar	300A	380A	480A	600A	750A
E_s	2	0...999 GW/h					300A	380A	480A	600A	750A
ErA, ErV	2	0...999 GW/h					300A	380A	480A	600A	750A
f	0.02	50...60 Hz					-				
I	2	12.5A	12.5A	12.5A	12.5A	12.5A	300A	380A	480A	600A	750A
I_N	2	12.5A	12.5A	12.5A	12.5A	12.5A	300A	380A	480A	600A	750A
U	0.05	88...690V					-				
P_{FA}	0.05	-					300A	380A	480A	600A	750A
THDu	5	110...690V					-				
THDi	5	250A	250A	250A	250A	250A	-				
		250A	320A	400A	500A	630A	-				

DPX³ 630 electronic circuit breakers

Reference(s) :
 from 4 220 56 to 4 220 95;
 from 4 220 96 to 4 221 35;
 from 4 221 36 to 4 221 75;
 from 4 221 76 to 4 222 15;
 from 4 224 98 to 4 225 37;

9. EQUIPMENTS AND ACCESSORIES

9.1 Earth leakage modules

Earth leakage characteristics for DPX ³ 630		
	Standard	with Led
Type	A - S	A - S
Uninterrupted nominal current I _n (A)	up to 630	up to 630
Rated isolated voltage U _i (V AC)	500	500
Rated operating voltage U _e (V AC) (50-60Hz)	500	500
Operating voltage (V AC) (50-60Hz)	230 ÷ 500	110 ÷ 500
Nominal frequency (Hz)	50 - 60	50 - 60
Operating temperature (°C)	-25 ÷ 70	-25 ÷ 70
Trip	electronic	electronic
Earth leakage time adjustments (s)	0 - 0.3 - 1 - 3	0 - 0.3 - 1 - 3
Earth leakage breaking capacity I _{dm} (% I _{cu})	60	60
Earth leakage protection adjustments I _{Δn} (A)	0.03 ÷ 3	0.03 ÷ 3
Side-by-side mounting	no	no
Underneath mounting	yes	yes
50% Earth fault detection contact I _{Δn}	no	yes
Clip on rail DIN 35	no	no
Dimensions (W x H x D) (mm) for 4P	183 x 152 x 105	183 x 152 x 106

(Power losses, see par. 5.4)

Standard

I_n ≤ 400A 3P *ref. 0 260 60*
 4P *ref. 0 260 61*
 I_n = 500A-630A 3P *ref. 0 260 64*
 4P *ref. 0 260 65*

LED version

I_n ≤ 400A 4P *ref. 0 260 63*
 I_n = 500A-630A 4P *ref. 0 260 67*

9.2 Releases (for DPX³ 630 / DPX³ 1600)

• shunt releases with voltage:
 24 Vac and dc *ref. 4 222 39*
 48 Vac and dc *ref. 4 222 40*
 110÷130 Vac and dc *ref. 4 222 41*
 220÷250 Vac and dc *ref. 4 222 42*
 380÷440 Vac and dc *ref. 4 222 43*

Shunt releases electrical characteristics	
Rated voltage (U _e)	Both ac and dc: 24V/48V/110÷130V/220÷250V/380÷440V
Voltage range (%U _e)	70 ÷ 110
Intervention time (ms)	≤ 50
Power consumption (W/VA)	300
Minimum opening time (ms)	50 ms
Insulation voltage (kV)	2,5

• undervoltage releases with voltage:
 24 V dc *ref. 4 222 44*
 24 V ac *ref. 4 222 45*
 48 V dc *ref. 4 222 46*
 110 - 125 V ac *ref. 4 222 47*
 220 - 240 V ac *ref. 4 222 48*
 380 - 415 V ac *ref. 4 222 49*

Undervoltage releases electrical characteristics	
Rated voltage (U _e)	ac: 24V/110÷125V/220÷240V/380÷415V dc: 24V/48V
Voltage range (%U _e)	85 ÷ 110
Minimum opening time (ms)	50
Power consumption (W/VA)	1.6 / 5

• time-lag undervoltage releases (800 ms)
Time-lag modules with voltage:
 230 V ac *ref. 0 261 90*
 400 V ac *ref. 0 261 91*

Universal Release *ref. 4 226 23*
 (to be equipped with a time-lag module 0 261 90/91)

9.3 Auxiliary contacts (for DPX³ 630 / DPX³ 1600)

Changeover switch 3A – 250 VAC *ref. 4 210 11*

To show the state of the contacts or opening of the DPX³/DPX³ -I on a fault:

- Auxiliary contact (standard) **OC**
- Fault signal **CTR**

Auxiliary contact electrical characteristics		
Rated voltage (V _n)	V (ac or dc)	24 to 250
Intensity (A)	24 V dc	5
	48 V dc	1.7
	110 V dc	0.5
	230 V dc	0.25
	110 V ac	4
	230/250 V ac	3

Configurations:

DPX³ 630 → 2 auxiliary contacts + 1 fault signal + 1 release

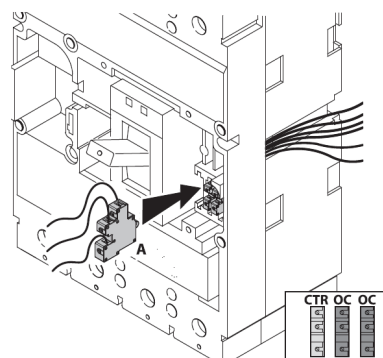

To get more information on auxiliary mounting procedures, please refer to product instruction sheet.

9.4 Universal keylocks

These keylocks must be used for all the accessories that can be locked:

- rotary handle
- motor operator
- plug-in mechanism
- draw-out mechanism

For each of these, a specific accessory (indicated in the specific section of this datasheet) must be added in order to get the complete locking kits for the specific application.

- 1 lock + 1 flat key with random mapping *ref. 4 238 80*
- 1 lock + 1 flat key with fixed mapping (EL43525) *ref. 4 238 81*
- 1 lock + 1 flat key with fixed mapping (EL43363) *ref. 4 238 82*
- 1 lock + 1 star key with random mapping *ref. 4 238 83*

DPX³ 630 electronic circuit breakers

Reference(s) :
 from 4 220 56 to 4 220 95;
 from 4 220 96 to 4 221 35;
 from 4 221 36 to 4 221 75;
 from 4 221 76 to 4 222 15;
 from 4 224 98 to 4 225 37;

9.5 Rotary handles

Direct on DPX³ (with auxiliary option)

- Standard (black) *ref. 0 262 41*
- For emergency use (red / yellow) adapting on standard handle *ref. 4 222 38*

Vari-depth handle IP55 (with auxiliary option)

- Standard (black) *ref. 0 262 81*
- For emergency use (red / yellow) adapting on standard handle *ref. 0 262 82*

Locking accessories (for vary-depth handle with auxiliary option)

- Key lock accessory for vari-depth rotary handle *ref. 4 228 07*

Ref. 4 238 07 must be used with universal keylocks to get the complete locking kit for rotary handle

Locking accessories (for direct handle)

- Key barrel and flat key *ref. 0 262 25*

Direct on DPX³ (no auxiliary option and door defeat function)

- Standard (black) *ref. 4 201 62*
- For emergency use (red / yellow) adapting on standard handle *ref. 4 201 65*

Vari-depth handle IP55 (no auxiliary option and door defeat function)

- Standard (black) *ref. 4 201 63*
- For emergency use (red / yellow) adapting on standard handle *ref. 4 201 76*

9.6 Motor operators (front operated)

For general purpose operations (direct action type):

- 230 V ac *ref. 4 226 30*

For synchronized operations (energy storage type):

- 24 V ac and dc *ref. 0 261 40*
- 48 V ac and dc *ref. 0 261 41*
- 230 V ac *ref. 0 261 42*

	LG-4 226 30	LG-0 261 40-41-44	
Type	Direct drive	Energy storage	
Rated operating voltage (U _J) - AC	230V AC 50-60 Hz	24 - 48 - 230	
Rated operating voltage (U _J) - DC	230V AC 50-60 Hz	24 - 48 - 230	
Voltage range (%U _c)	85±110		85±110
	Opening	Closing	Closing
Pick-up consumption (W / VA)	240	200	300
Hold consumption (W / A)	80	120	300
Operating time / complete electric operation (ms)	450	550	2000
Operating time / main contacts change position (ms)	270	550	n/a
Mechanical endurance (O-C cycles) @I _n = 630A	10000		n/a
Electrical endurance (O-C cycles) @I _n = 630A	4000		4000
Cycles / minutes	up to 8 automatic open/close operations in a row		10
			4

Locking accessories

- Key lock accessory for motor operator *ref. 4 228 06*

Ref. 4 228 06 must be used with universal keylocks to get the complete locking kit for motor operator

9.7 Mechanical accessories

- Padlock (for locking in "OPEN" position) *ref. 0 262 40*
- Insulated shields (phase insulators) *ref. 0 262 30*
- Sealable terminal shields:
 - Set of 2 (for 3P) *ref. 0 262 44*
 - Set of 3 (for 4P) *ref. 0 262 45*
- Terminal covers to guarantee IP20:
 - Set of 2 (for 3P) *ref. 0 262 34*
 - Set of 3 (for 4P) *ref. 0 262 35*

9.8 Connection accessories

Cage terminals

- Set of 4 terminals for cables 300 mm² max (rigid) or 240 mm² max (flexible) Cu/Al *ref. 0 262 50*
- Set of 4 high-capacity terminals for cables 2x240 mm² max (rigid) or 2x185 mm² max (flexible) Cu/Al *ref. 0 262 51*

Extended front terminals

- Set of 4 *ref. 0 262 47*

Spreaders (incoming or outgoing):

- Set of 2 (for 3P) *ref. 0 262 48*
- Set of 3 (for 4P) *ref. 0 262 49*

Rear terminals (incoming or outgoing):

(used to convert the fixed version with front terminals into the fixed version with rear terminals)

- for 3P *ref. 0 263 52*
- for 4P *ref. 0 263 53*

Adaptor for lug

(for connecting bare cables with lugs)

- Set of 4 adaptors + insulated shields *ref. 0 262 46*

Cage terminal use specifications

DPX ³ 630			
Type of cage terminal	Cable standard suggested cross section (mm ²)*		
	In (A)	Cu	Al
Standard	250	120	185
	320	185	\
	400	240	\
	500	\	\
	630	\	\
High capacity	250	120	185
	320	185	2x120
	400	240	2x150
	500	2x150	2x240
	630	2x185	\

* The suggested cross section are in compliance with standard IEC60947-1 (ed.6 2020/04) and IEC60947-2 (ed.5.1 2019/07)

DPX³ 630 electronic circuit breakers

Reference(s) :

from 4 220 56 to 4 220 95;

from 4 220 96 to 4 221 35;

from 4 221 36 to 4 221 75;

from 4 221 76 to 4 222 15;

from 4 224 98 to 4 225 37;

DPX ³ 630		
Type of cage terminal	Dimensions limits of cable for cage terminals	
	MIN/MAX cross section (mm ²)	
	Flexible	Rigid
Standard	6 mm ² / 240 mm ²	4 mm ² / 300 mm ²
High capacity	70 mm ² / 185 mm ²	35 mm ² / 240 mm ²

DPX³ 630 electronic circuit breakers

Reference(s) :
from 4 220 56 to 4 220 95;
from 4 220 96 to 4 221 35;
from 4 221 36 to 4 221 75;
from 4 221 76 to 4 222 15;
from 4 224 98 to 4 225 37;

9.9 Plug-in version

(A plug-in is a DPX³ fitted with special terminals and mounted on a plug-in base)

Special terminals for plug-in / draw-out base (for incoming and outgoing terminals)

- Set of 6 terminals (3P) *ref. 4 222 20*
- Set of 8 terminals (4P) *ref. 4 222 21*

Bases

(accept DPX³/DPX³-I fitted with special terminals)

- Front terminal mounting base for 3P *ref. 4 222 22*
- Front terminal mounting base for 4P *ref. 4 222 23*
- Flat rear terminal mounting base for 3P *ref. 4 222 24*
- Flat rear terminal mounting base for 4P *ref. 4 222 25*

Bases for breakers with mounted earth leakage module

- Front terminal mounting base for 4P *ref. 4 222 26*
- Flat rear terminal mounting base for 4P *ref. 4 222 27*

Accessories

- Set of 2 extractor handle *ref. 4 222 28*
- Set of connectors (24-pin) *ref. 4 222 29*

9.10 Draw-out version

(A DPX³ draw-out version is a plug-in DPX³ fitted with a "Debro-lift" mechanism which can be used to withdraw the DPX³ while keeping it on its base)

"Debro-lift" mechanism

(supplied with a rigid slide and handle for drawing-out)

- For base only (3P) *ref. 4 222 31*
- For base only (4P) *ref. 4 222 32*
- For base with earth leakage module (4P) *ref. 4 222 33*

Keylock for "Debro-lift" mechanism

- One key for DPX³ only
(enable locking in draw - out position)

- Key lock accessory for draw-out
(frontal masks for motor operator or rotary handle) *ref. 4 228 08*
- Key lock accessory for draw-out *ref. 4 228 10*

Ref. 4 228 08 and 4 228 10 must be used with universal keylocks to get the complete locking kit for draw-out version

Accessories for "Debro-lift" mechanism

- Signalling contact (plugged-in / draw-out) *ref. 0 265 74*
- Handle for drawing - out *ref. 0 265 75*

Auxiliary contacts

- Automatic auxiliary contacts for draw-out version (up to 2 contacts by DPX³) *ref. 4 222 30*

Plate for transfer switches (factory assembled)

(A transfer switch plate is composed of one plate with interlock for 2 devices)

- Plate for breaker or trip-free switch fixed version *ref. 0 264 09*
- Plate for breaker or trip-free switch plug-in and draw-out version *ref. 0 264 04*

9.11 Specific accessories for electronic version

Auxiliary power supply

- For supplying electronic units *ref. 4 210 83*

Is used to supply DPX³ electronic circuit breakers S2/Sg with / without earth leakage module and with / without energy metering central unit. It is mandatory in case of electronic breakers with integrated measure and not interconnected in a supervision system (MODBUS network not requested) to correctly manage the measure functions

Technical characteristics:

- Input voltage: 24V ad/dc (+/- 10%)
- Enclosure: 2 DIN modules
- Output: up to 250mA (to supply many circuit breakers according to the following table):

4 210 83	DPX ³ 250 / 250HP / 630 / 1600	[mA]
I _{out} MAX = 250 mA	Electronic/Electronic + RCD (S2/Sg)	50
	Electronic/Electronic + RCD with power metering (S2/Sg)	62.5
	Electronic/Electronic + RCD (S10)	70
	Electronic/Electronic + RCD with power metering (S10)	83

According to single absorptions, it can be possible to connect more than one breaker

MODBUS communication

- RS485 MODBUS communication interface *ref. 4 210 75*

Is used for sharing on MODBUS network all information managed by DPX³ electronic circuit breakers S2/Sg with / without earth leakage module and with / without energy metering central unit.

Technical characteristics:

- USB local PC connection
- Input voltage: 24V ad/dc (+/- 10%)
- Enclosure: 1 DIN modules
- MODBUS address configuration / transmission mode / transmission speed by physic configurators
- Output relay (220V - 0,2A): to signal tripped position

Consumption: 90mA

It is possible to connect only one breaker to the interface.

In case of use of MODBUS interface 4 210 75, the external power supply module 4 210 83 is not necessary because the external power is already provided by the MODBUS module

Web server

- For remote viewing of values collected on electricity meters and multi-function measuring units
 - 32 metering points *ref. 0 261 78*
 - Unlimited metering points *ref. 0 261 79*

Software

- To display values collected on electricity meters and multi-function measuring units on a PC connected to the network
 - 32 metering points *ref. 0 261 88*
 - Unlimited metering points *ref. 0 261 89*

Touch screen

- To show data collected by DX³, DPX³, DMX³, EMDX³. It can manage up to 8 devices *ref. 0 261 56*

10. CURVES

10.1.1 Tripping curve (for S1 version) [1/3]

Update: 02/07/2018

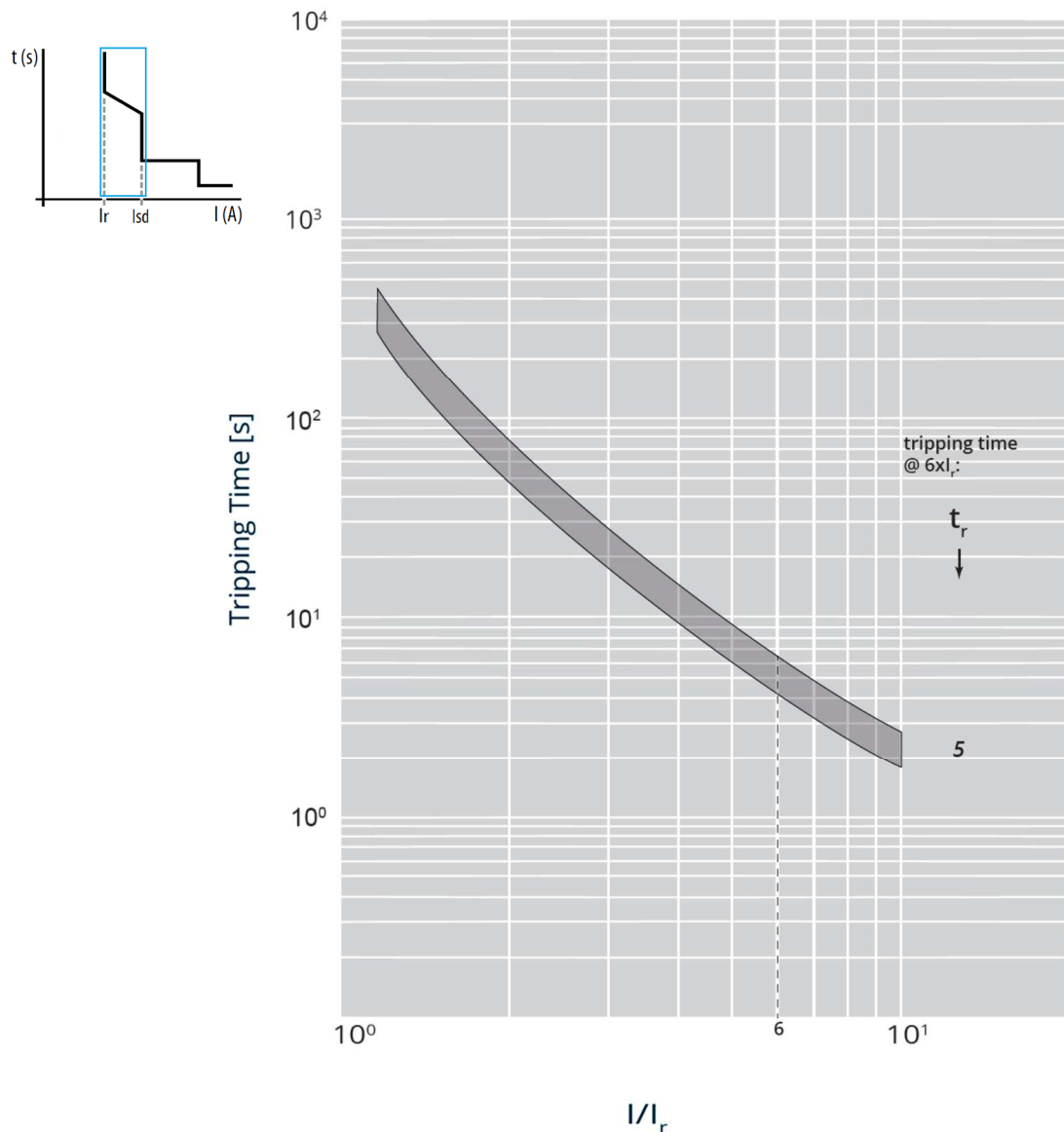

$I_{cu} = 36-50-70-100 \text{ kA}$ $I_{max} = 630A$ 3-4 P $U_o = 415Vac$ (IEC/EN 60947-2)

Value	Description
t	time
I	current
I_r	long time setting current
t_r	long time delay
I_{sd}	short time setting current
t_{sd}	short time delay
I_i	instantaneous release
I_{cu}	rated ultimate short-circuit breaking capacity
$I^2t = K$	constant pass-through energy setting
$t = K$	constant tripping time setting
—————	long time trip curve
-----	short time trip curve
Current tolerance	10% up to I_{sd} ; 20% up to I_i

DPX³ 630 electronic circuit breakers

Reference(s) :
 from 4 220 56 to 4 220 95;
 from 4 220 96 to 4 221 35;
 from 4 221 36 to 4 221 75;
 from 4 221 76 to 4 222 15;
 from 4 224 98 to 4 225 37;

10.1.2 Tripping curve (for S1 version)

[2/3]

Update: 03/12/2018

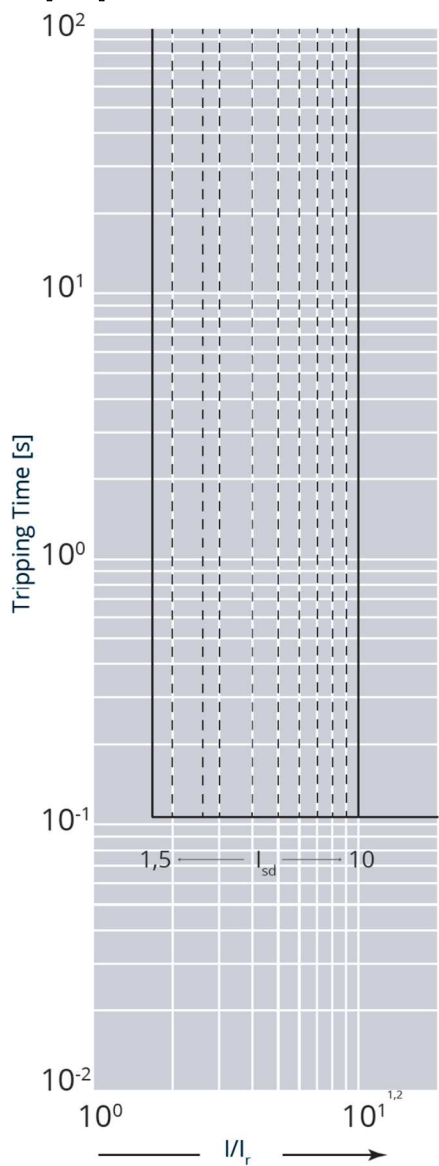
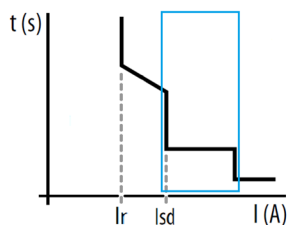

$I_{cu} = 36-50-70-100 \text{ kA}$ $I_{max} = 630A$ 3-4 P $U_0 = 415Vac$ (IEC/EN 60947-2)

Value	Description
t	time
I	current
I_r	long time setting current
t_r	long time delay
I_{sd}	short time setting current
t_{sd}	short time delay
I_i	instantaneous release
I_{cu}	rated ultimate short-circuit breaking capacity
$I^2t = K$	constant pass-through energy setting
$t = K$	constant tripping time setting
-----	long time trip curve
-----	short time trip curve
Current tolerance	10% up to I_{sd} ; 20% up to I_i

DPX³ 630 electronic circuit breakers

Reference(s) :
 from 4 220 56 to 4 220 95;
 from 4 220 96 to 4 221 35;
 from 4 221 36 to 4 221 75;
 from 4 221 76 to 4 222 15;
 from 4 224 98 to 4 225 37;

10.1.3 Tripping curve (for S1 version)

[3/3]

Update: 02/07/2018

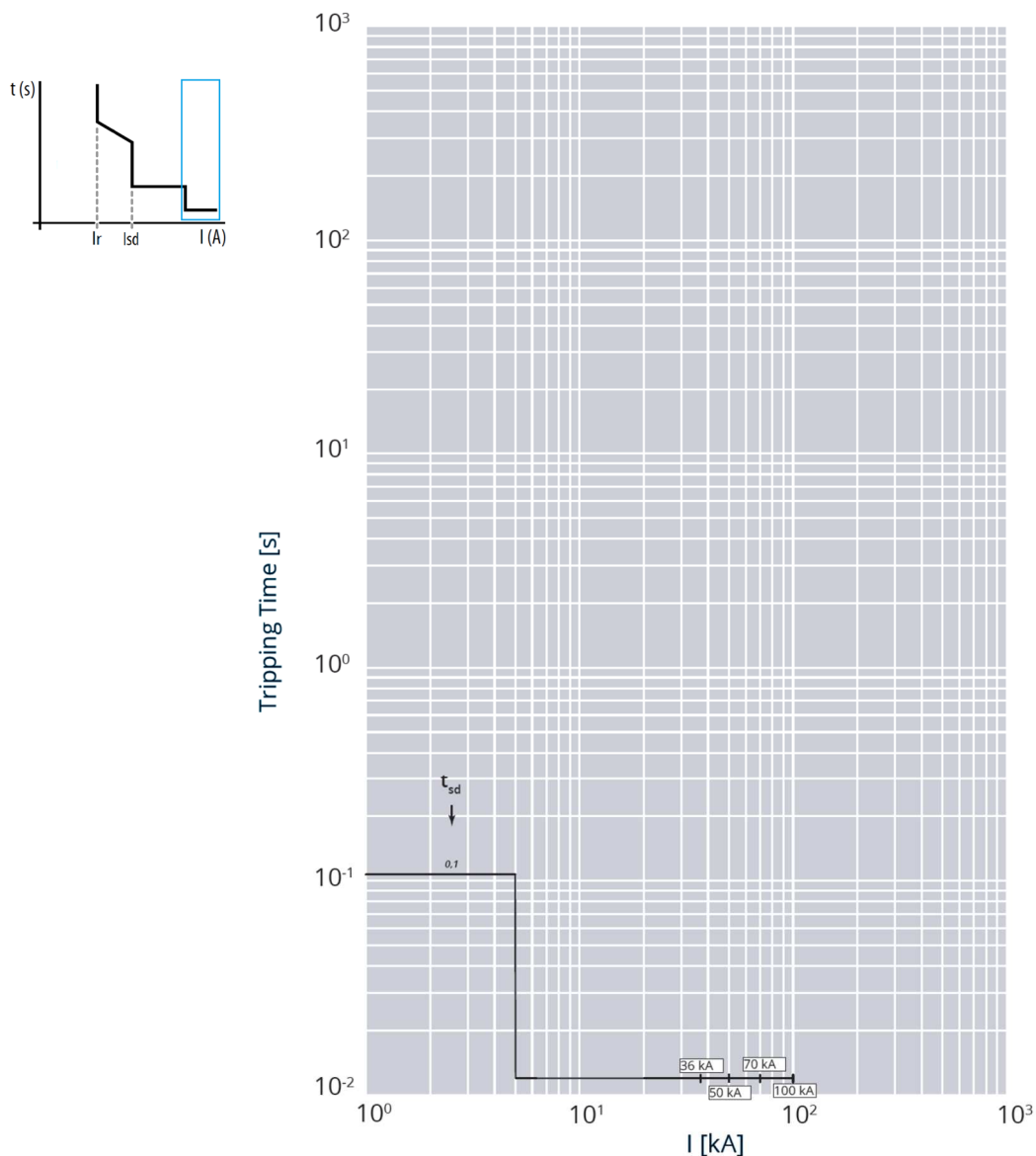

$I_{cu} = 36-50-70-100 \text{ kA}$ $I_{max} = 630A \text{ 3-4 P}$ $U_o = 415Vac$ (IEC/EN 60947-2)
Fixed Instantaneous override $I_{sf} = 5kA$

Value	Description
t	time
I	current
I_r	long time setting current
t_r	long time delay
I_{sd}	short time setting current
t_{sd}	short time delay
I_i	instantaneous release
I_{cu}	rated ultimate short-circuit breaking capacity
$I^2t = K$	constant pass-through energy setting
$t = K$	constant tripping time setting
-----	long time trip curve
-----	short time trip curve
Current tolerance	10% up to I_{sd} ; 20% up to I_i

DPX³ 630 electronic circuit breakers

Reference(s) :
 from 4 220 56 to 4 220 95;
 from 4 220 96 to 4 221 35;
 from 4 221 36 to 4 221 75;
 from 4 221 76 to 4 222 15;
 from 4 224 98 to 4 225 37;

10.2.1 Tripping curve (for S2/Sg version), $t_r = 3+15$ s [1/5]

Update: 03/12/2018

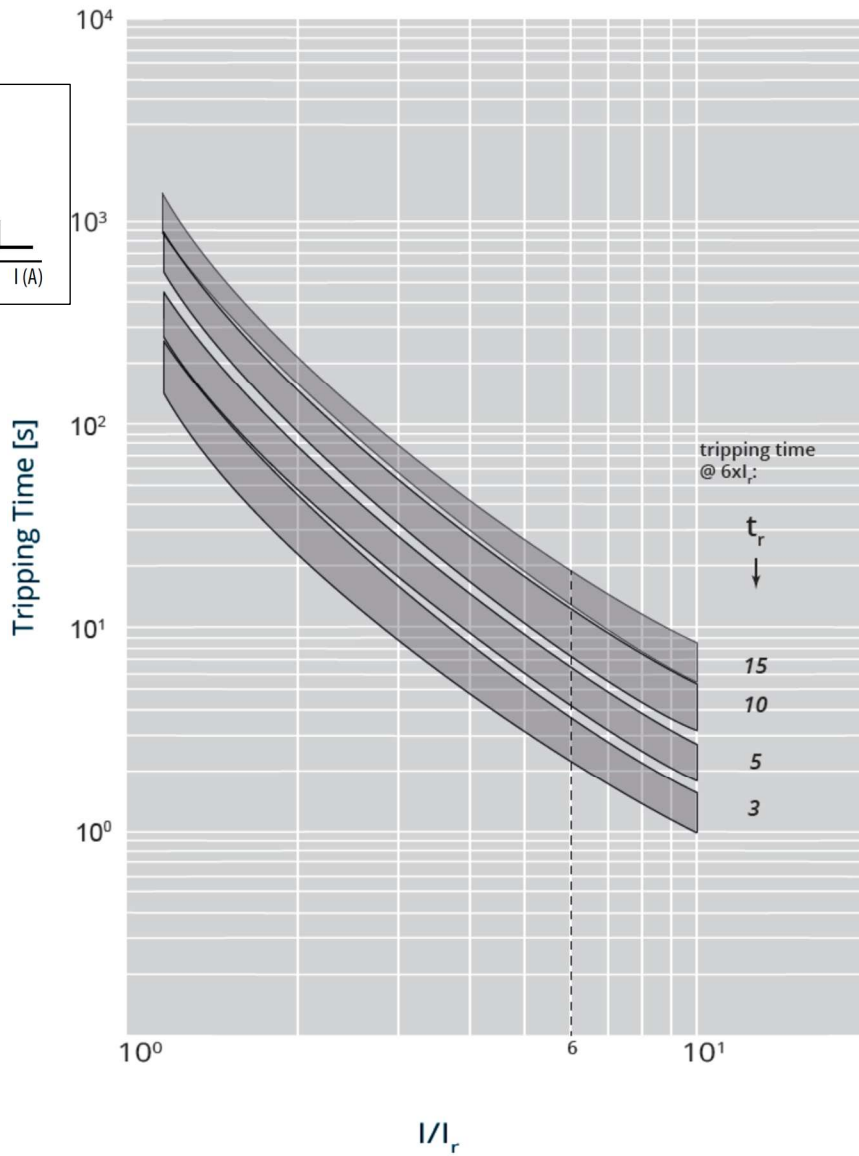
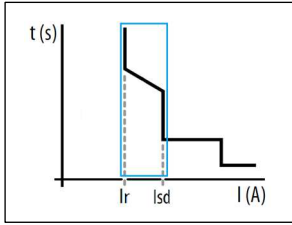

$I_{cu} = 36-50-70-100$ kA $I_{max} = 630A$ 3-4 P $U_o = 415Vac$ (IEC/EN 60947-2)

Value	Description
t	time
I	current
I_r	long time setting current
t_r	long time delay
I_{sd}	short time setting current
t_{sd}	short time delay
I_i	instantaneous release
I_{cu}	rated ultimate short-circuit breaking capacity
$I^2t = K$	constant pass-through energy setting
$t = K$	constant tripping time setting
—————	long time trip curve
-----	short time trip curve
Current tolerance	10% up to I_{sd} ; 20% up to I_i

DPX³ 630 electronic circuit breakers

Reference(s) :
 from 4 220 56 to 4 220 95;
 from 4 220 96 to 4 221 35;
 from 4 221 36 to 4 221 75;
 from 4 221 76 to 4 222 15;
 from 4 224 98 to 4 225 37;

10.2.2 Tripping curve (for S2/Sg version), $t_r = 20$ s [2/5]

Update: 02/07/2018

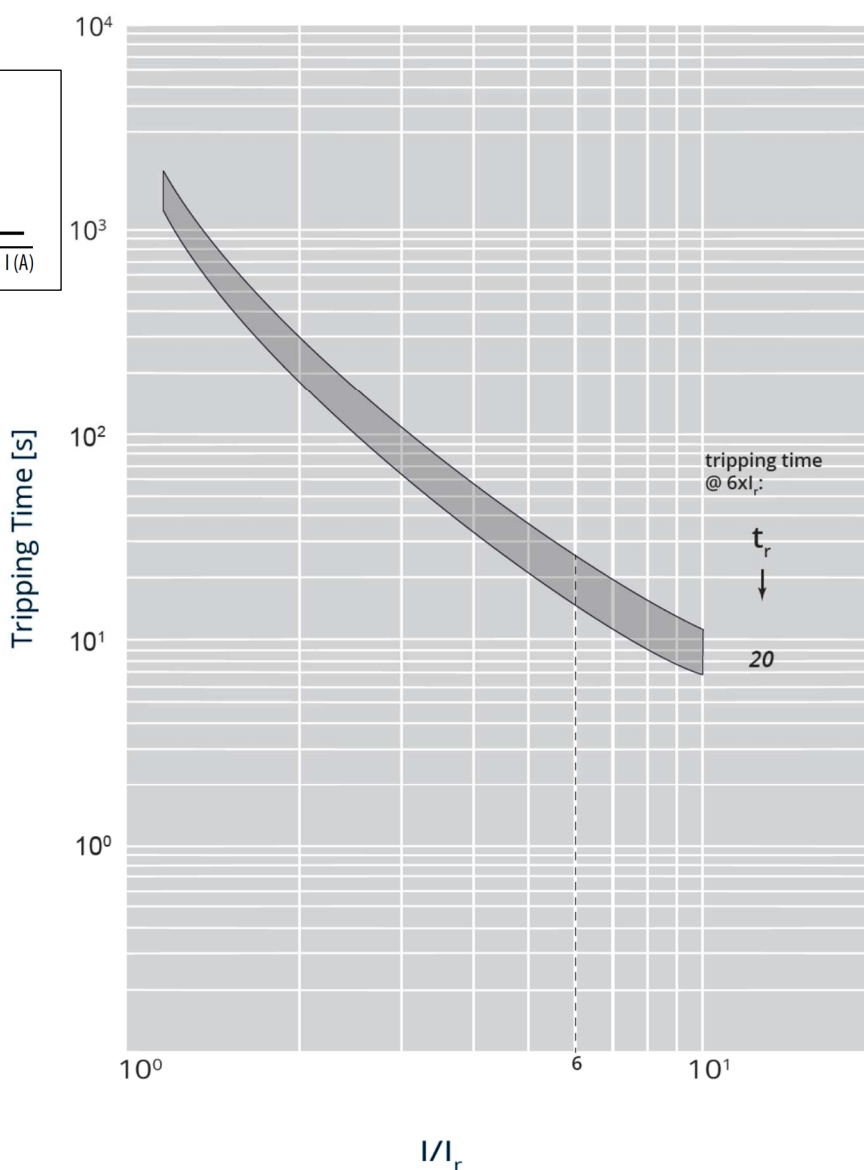
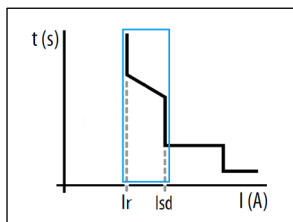

$I_{cu} = 36-50-70-100$ kA $I_{max} = 630A$ 3-4 P $U_0 = 415Vac$ (IEC/EN 60947-2)

Value	Description
t	time
I	current
I_r	long time setting current
t_r	long time delay
I_{sd}	short time setting current
t_{sd}	short time delay
I_i	instantaneous release
I_{cu}	rated ultimate short-circuit breaking capacity
$I^2t = K$	constant pass-through energy setting
$t = K$	constant tripping time setting
—————	long time trip curve
-----	short time trip curve
Current tolerance	10% up to I_{sd} ; 20% up to I_i

DPX³ 630 electronic circuit breakers

Reference(s) :
 from 4 220 56 to 4 220 95;
 from 4 220 96 to 4 221 35;
 from 4 221 36 to 4 221 75;
 from 4 221 76 to 4 222 15;
 from 4 224 98 to 4 225 37;

10.2.3 Tripping curve (for S2/Sg version), $t_r = 25+30$ s [3/5]

Update: 02/07/2018

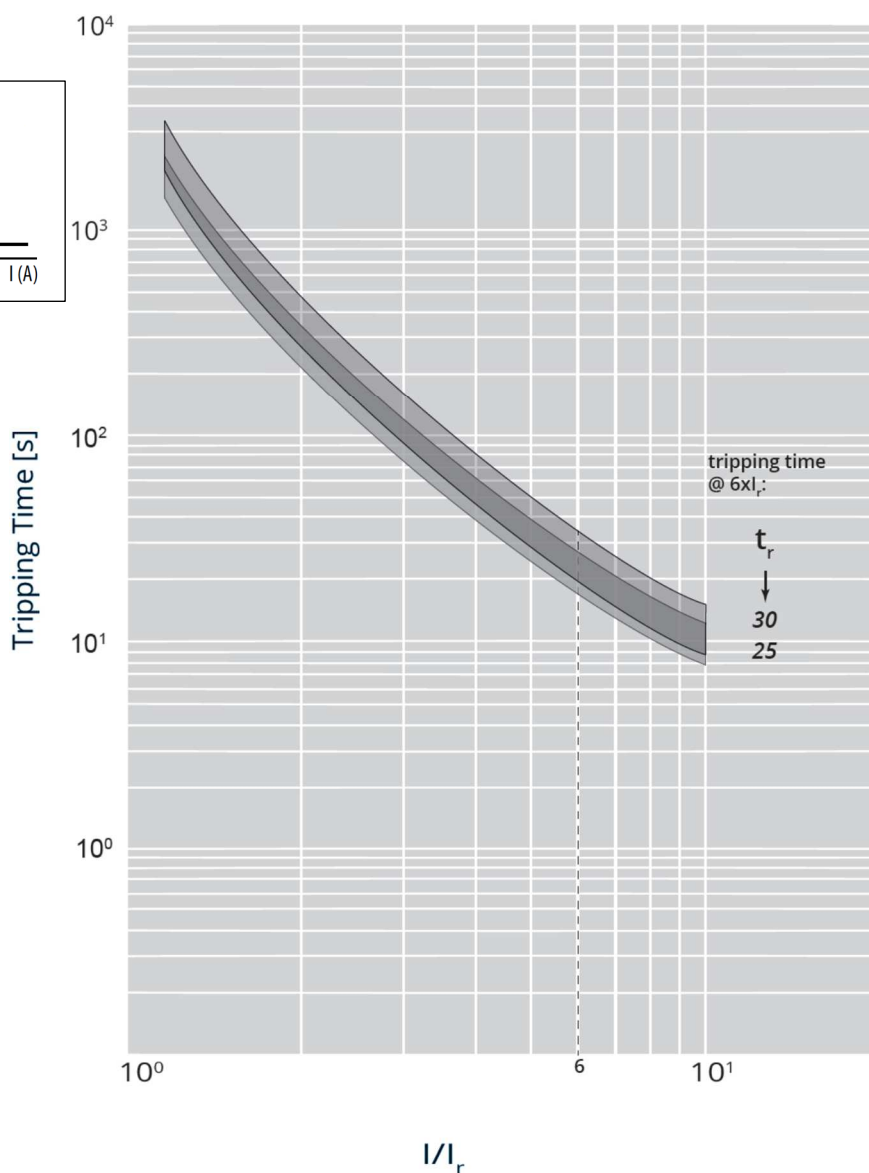
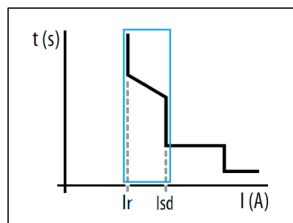

$I_{cu} = 36-50-70-100$ kA $I_{max} = 630A$ 3-4 P $U_0 = 415Vac$ (IEC/EN 60947-2)

Value	Description
t	time
I	current
I_r	long time setting current
t_r	long time delay
I_{sd}	short time setting current
t_{sd}	short time delay
I_i	instantaneous release
I_{cu}	rated ultimate short-circuit breaking capacity
$I^2t = K$	constant pass-through energy setting
$t = K$	constant tripping time setting
-----	long time trip curve
-----	short time trip curve
Current tolerance	10% up to I_{sd} ; 20% up to I_i

DPX³ 630 electronic circuit breakers

Reference(s) :
 from 4 220 56 to 4 220 95;
 from 4 220 96 to 4 221 35;
 from 4 221 36 to 4 221 75;
 from 4 221 76 to 4 222 15;
 from 4 224 98 to 4 225 37;

10.2.4 Tripping curve (for S2/Sg version) [4/5]

Update:
02/07/2018

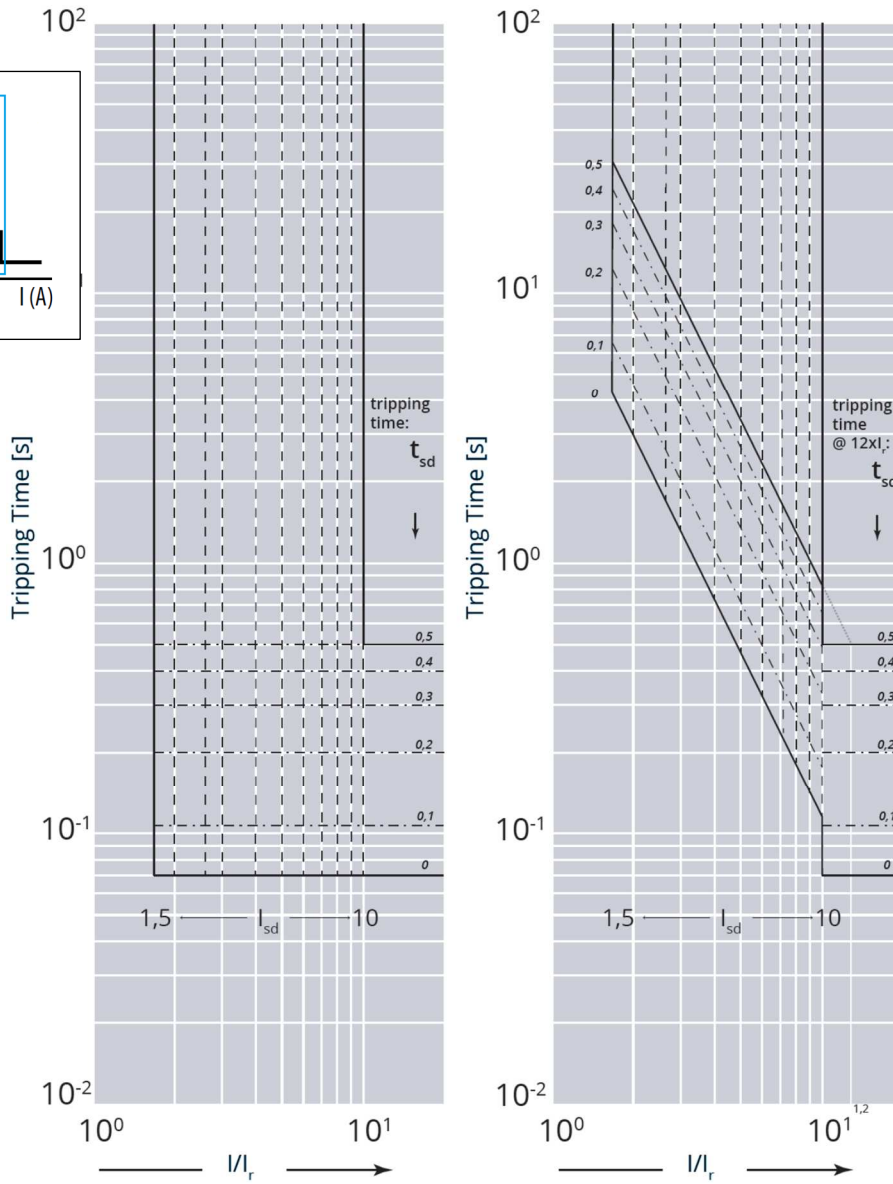
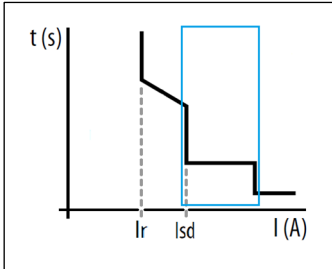

$I_{cu} = 36-50-70-100 \text{ kA}$ $I_{max} = 630A$ 3-4 P $U_0 = 415Vac$ (IEC/EN 60947-2)

Value	Description
t	time
I	current
I_r	long time setting current
t_r	long time delay
I_{sd}	short time setting current
t_{sd}	short time delay
I_i	instantaneous release
I_{cu}	rated ultimate short-circuit breaking capacity
$I^2t = K$	constant pass-through energy setting
$t = K$	constant tripping time setting
—————	long time trip curve
-----	short time trip curve
Current tolerance	10% up to I_{sd} ; 20% up to I_i

DPX³ 630 electronic circuit breakers

Reference(s) :
 from 4 220 56 to 4 220 95;
 from 4 220 96 to 4 221 35;
 from 4 221 36 to 4 221 75;
 from 4 221 76 to 4 222 15;
 from 4 224 98 to 4 225 37;

10.2.5 Tripping curve (for S2/Sg version) [5/5]

Update: 02/07/2018

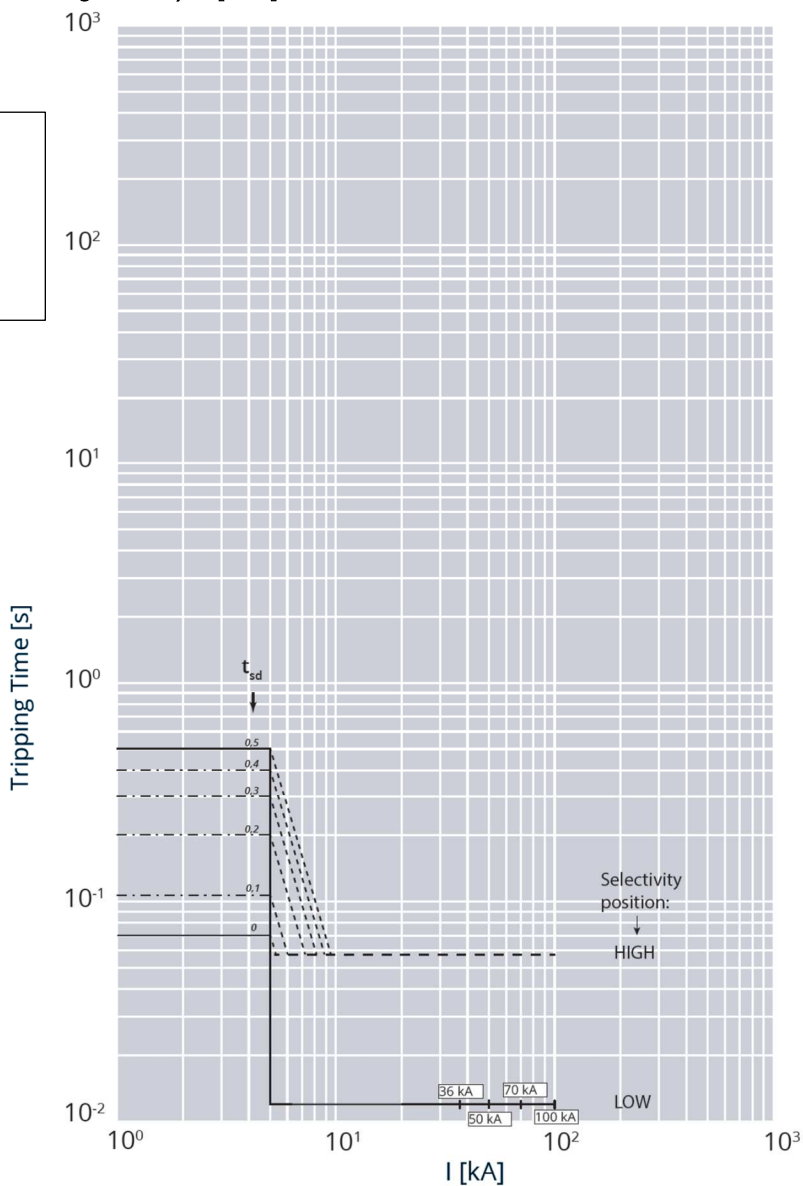
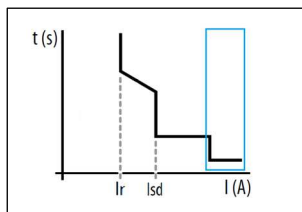

$I_{cu} = 36-50-70-100 \text{ kA}$ $I_{max} = 630\text{A}$ 3-4 P $U_0 = 415\text{Vac}$ (IEC/EN 60947-2)

Fixed Instantaneous override $I_{sf} = 5\text{kA}$

Value	Description
t	time
I	current
I_r	long time setting current
t_r	long time delay
I_{sd}	short time setting current
t_{sd}	short time delay
I_i	instantaneous release
I_{cu}	rated ultimate short-circuit breaking capacity
$I^2t = K$	constant pass-through energy setting
$t = K$	constant tripping time setting
—————	long time trip curve
-----	short time trip curve
Current tolerance	10% up to I_{sd} ; 20% up to I_i

10.3 Pass-through specific energy characteristic curve

Update: 03/07/2018

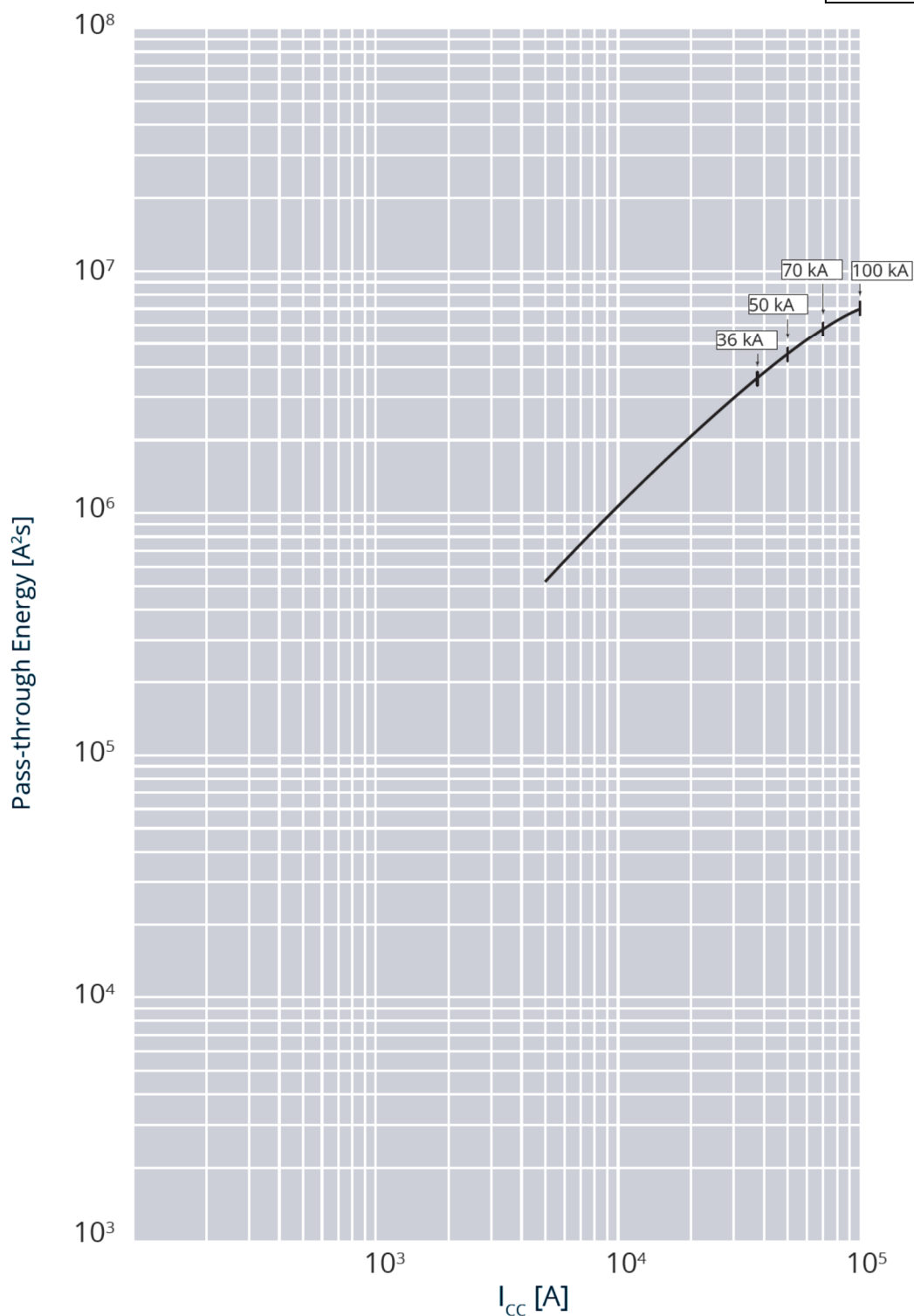

$I_{cu} = 36-50-70-100 \text{ kA}$ $I_{max} = 630A$ 3-4 P $U_o = 415Vac$ (IEC/EN 60947-2)

Value	Description
I_{cc}	short circuit current
I^2t (A ² s)	pass-through specific energy

10.4 Cut-off peak current characteristic curve (kA)

Update: 02/07/2018

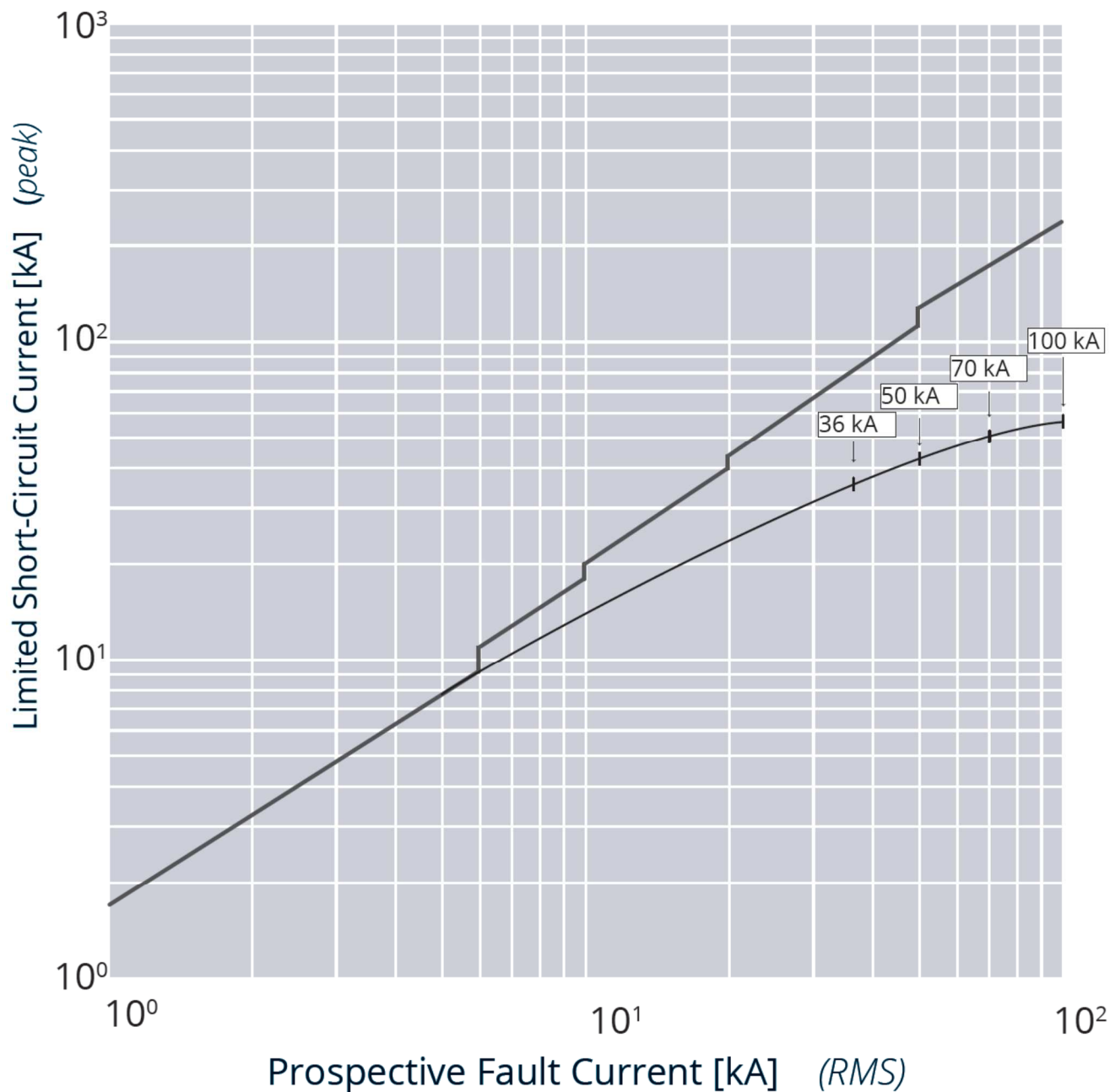

$I_{cu} = 36-50-70-100 \text{ kA}$ $I_{max} = 630A$ 3-4 P $U_o = 415Vac$ (IEC/EN 60947-2)

Value	Description
I_{cc}	estimated short circuit symmetrical current (RMS value)
I_p	maximum short circuit peak current
	maximum prospective short circuit peak current corresponding at the power factor
	maximum real peak short circuit current

DPX³ 630 electronic circuit breakers

Reference(s) :
 from 4 220 56 to 4 220 95;
 from 4 220 96 to 4 221 35;
 from 4 221 36 to 4 221 75;
 from 4 221 76 to 4 222 15;

A) Derating Temperature and configurations

		Ambient temperature									
		30 °C		40 °C		50 °C		60 °C		70 °C	
Fixed version		I_{max} (A)	I_r / I_n	I_{max} (A)	I_r / I_n	I_{max} (A)	I_r / I_n	I_{max} (A)	I_r / I_n	I_{max} (A)	I_r / I_n
DPX ³ 630 fixed	Cage terminals, flexible cable	630	1	630	1	630	1	599	0.95	567	0.9
	Lugs, flexible cable	630	1	630	1	630	1	567	0.9	536	0.85
	Lugs, rigid cable	630	1	630	1	630	1	599	0.95	567	0.9
	Spreaders, flexible cable	630	1	630	1	630	1	536	0.85	504	0.8
	Rear flat staggered terminals, flexible cable	630	1	630	1	630	1	567	0.9	536	0.85
DPX ³ 630 fixed + RCD	Cage terminals, flexible cable + RCD	630	1	630	1	536	0.85	504	0.9	473	0.75
	Lugs, flexible cable + RCD	599	0.95	599	0.95	536	0.85	504	0.8	473	0.75
	Lugs, rigid cable + RCD	630	1	599	0.95	536	0.85	504	0.8	473	0.75
	Staggered spreaders, flexible cable + RCD	630	1	630	1	536	0.85	504	0.8	473	0.75
	Rear flat staggered terminals, flexible cable + RCD	630	1	630	1	536	0.85	504	0.8	473	0.75
Draw-out version		I_{max} (A)	I_r / I_n	I_{max} (A)	I_r / I_n	I_{max} (A)	I_r / I_n	I_{max} (A)	I_r / I_n	I_{max} (A)	I_r / I_n
DPX ³ 630 draw-out	Cage terminals, flexible cable	599	0.95	567	0.9	536	0.85	504	0.8	441	0.7
	Cage terminals, rigid cable	599	0.95	567	0.9	536	0.85	504	0.8	441	0.7
	Rear flat terminals, flexible cable	599	0.95	567	0.9	536	0.85	504	0.8	441	0.7
	Rear flat terminals, rigid cable	599	0.95	567	0.9	536	0.85	504	0.8	441	0.7
	Rear flat terminals, Cu bars, vertical	599	0.95	567	0.9	536	0.85	504	0.8	441	0.7
DPX ³ 630 draw-out + RCD	Cage terminals, flexible cable + RCD	504	0.8	441	0.7	410	0.65	378	0.6	347	0.5
	Cage terminals, rigid cable + RCD	504	0.8	441	0.7	410	0.65	378	0.6	347	0.5
	Rear flat terminals, flexible cable + RCD	504	0.8	441	0.7	410	0.65	378	0.6	347	0.5
	Rear flat terminals, rigid cable	504	0.8	441	0.7	410	0.65	378	0.6	347	0.5
	Rear flat terminals, Cu bars, vertical + RCD	504	0.8	441	0.7	410	0.65	378	0.6	347	0.5

For further technical information, please contact Legrand technical support.

Data indicated in this document refers exclusively to test conditions according to product standards, unless otherwise indicated in the documentation.

For the different conditions of use of the product, inside electrical equipment or in any case inserted in the installation context, refer to the regulatory requirements of the equipment, local regulations and design specifications of the system.