

The battery tank installation instructions

User hello:

Thank you for using our products, in order to you can correct use UPS battery cabinet series products, please read this before installation the instructions.

Note:

1. must be strong, battery cabinet, indoor installation site leveling, ensure the install ation cabinet put oneself in another's vertical to the ground.
2. the structure of the battery cabinet is assembled, the battery tank heating panel installation and check when the bottom and side Cannot be completely removed, otherwise it will affect the structure of cabinet put oneself in another's safety.
3. battery cabinet after the installation is complete, ban mobile shake, prohibited place heavy objects at the top of the tank.

(C-1.C-1A.C-1B battery box series:)

(Installation instructions: one-piece installation)

(Name of the component:)

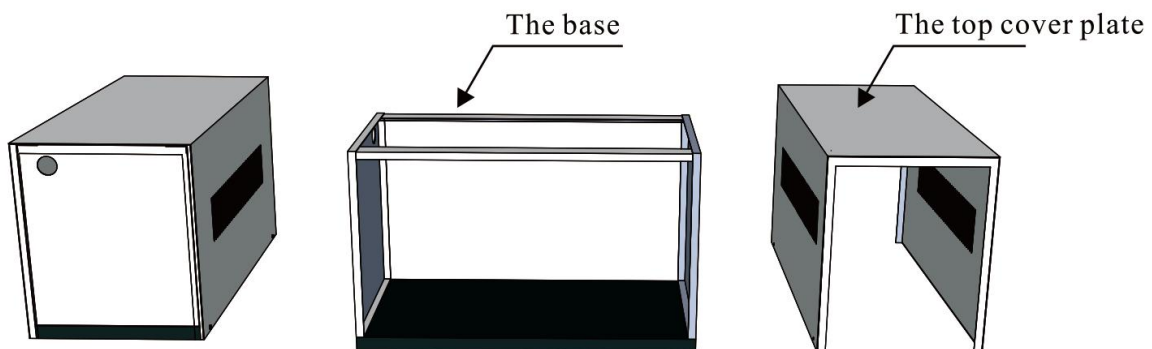

C-1 legend

C - 2, C - 3 battery box series.

Name of the component:

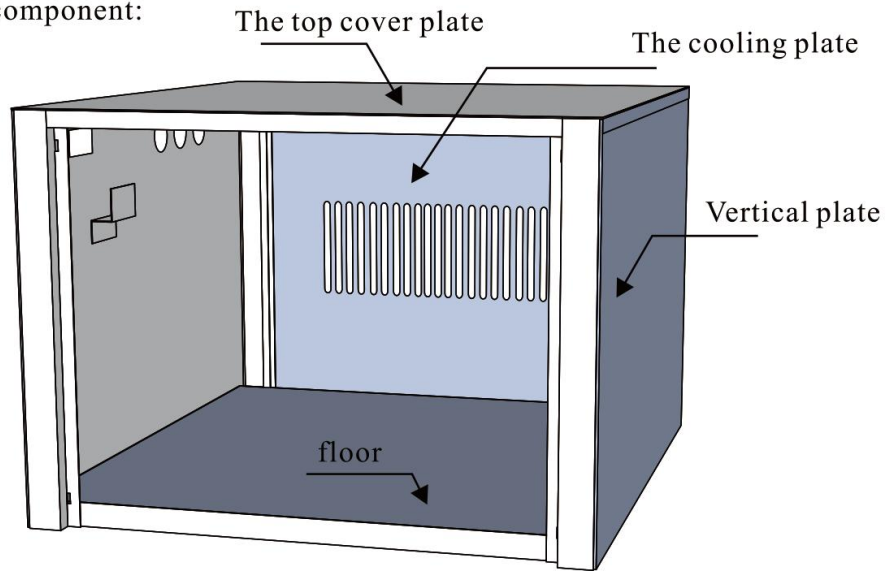

C-2 legend

Installation instructions:

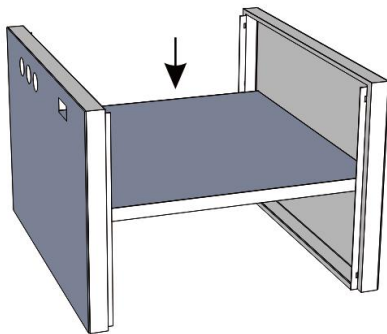

1: 2 pieces set installation plate and bottom plate

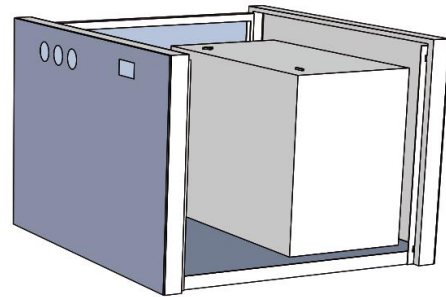

2: Installed on one side of the radiator panels and batteries

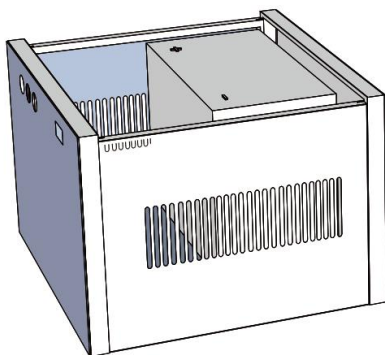

3: According to the requirements of using connected battery with the host The cables before installation radiator panels

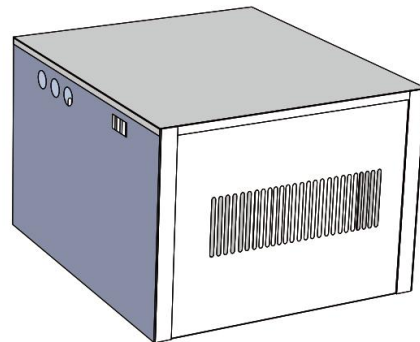

4: The final check on the back cover the top cover plate

C - 4, C - 6, C - 8 -, C - 10 battery cabinet series:

Name of the component:

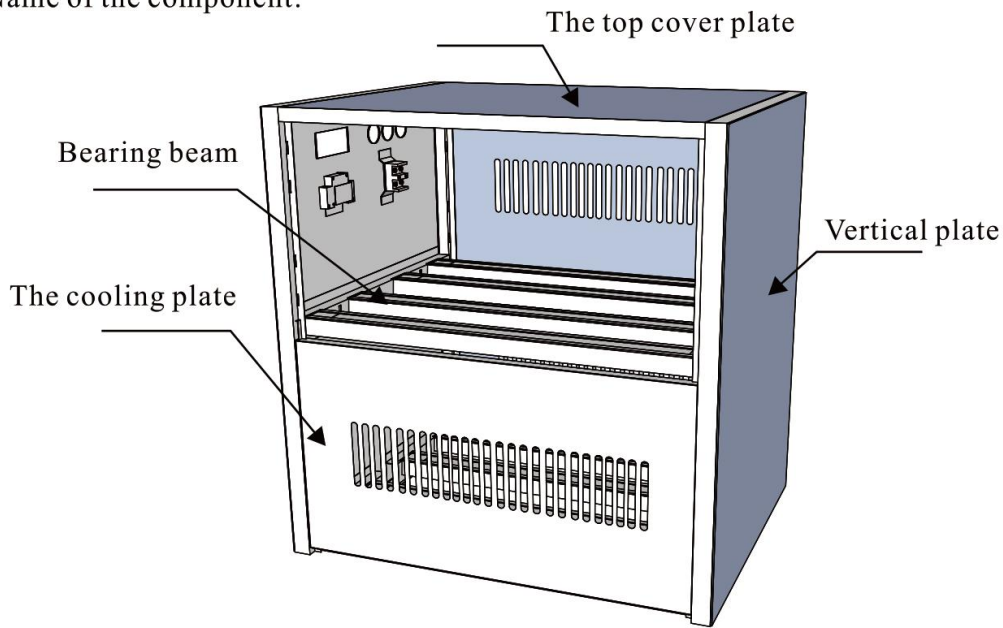

C-6 legend

Installation instructions:

1



First take out 2 pieces of plate, Then in the upper bearing Intermediate bayonet into 2 Bearing beam as a fixed, however After installing the bottom bearing beam of the four.

2

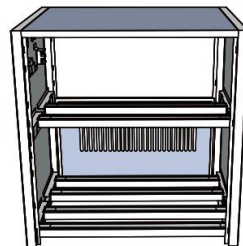

Nstall the bottom left (or right) a hot plate, and cover on the top cover plate cabinet put oneself in another's position of adjustment horn line, make cabinet put oneself in another's position is flat and level, remove the top cover plate.

3

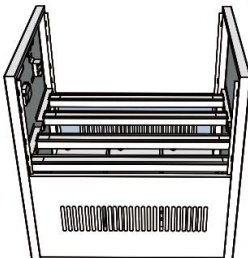

Installed at the bottom of a set of electricity pool connected according to the requirements of use cell line, the installation or left another hot plate right.

4

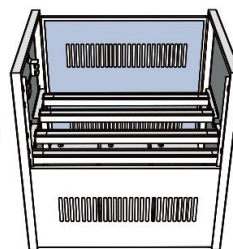

Install the bearing beam on the second floor According to the three points method to complete the installation of chizu connected cell line to host connection.

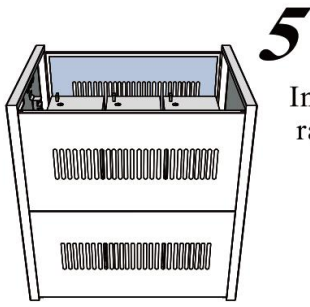

Install the left or the right radiator panels.

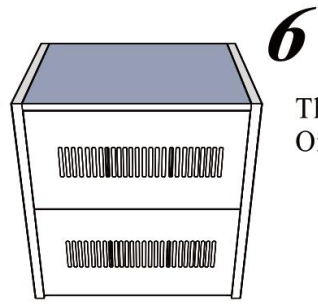

The last check back cover
On the top cover plate.

(pictures listed in this manual are for reference only, product specifications and appearance are subject to change without prior notice)

C - 12, C - 1 6, C - 20 -, C - 24,C-32 battery cabinet series:

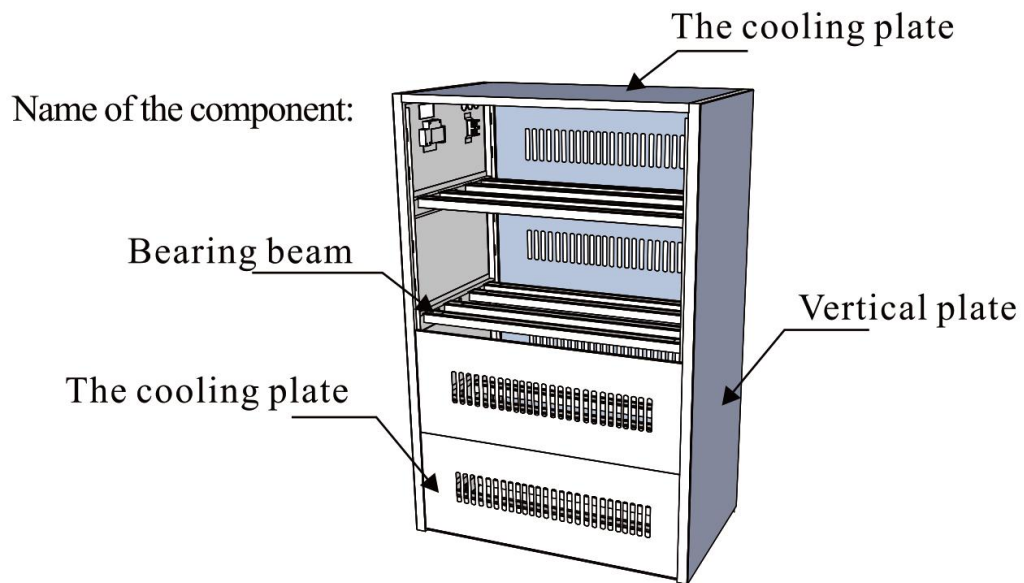

C-16 legend

Installation instructions:

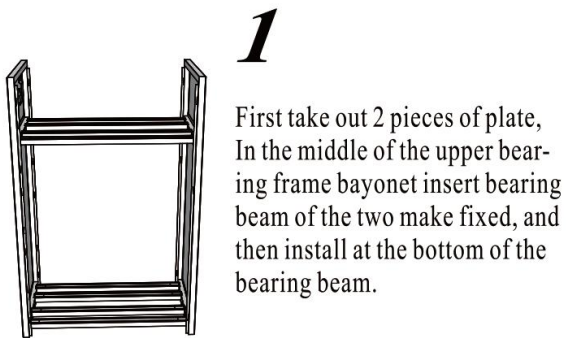

1

First take out 2 pieces of plate, In the middle of the upper bearing frame bayonet insert bearing beam of the two make fixed, and then install at the bottom of the bearing beam.

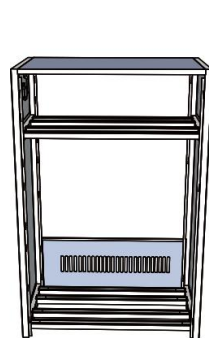

2

Install the bottom left (or right) a hot plate, then cover the top cover plate, adjust cabinet put oneself in another's position of diagonal, make cabinet put oneself in another's position is flat and level.

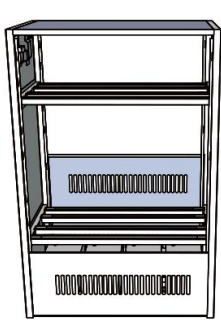

3

Installed at the bottom of a set of batteries according to the requirements of using connected battery line, the installation of left or right to another a hot plate, and then take off Top cover plate.

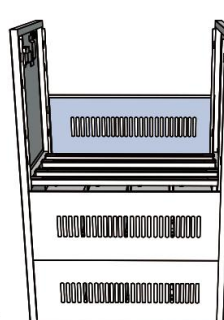

4

Install bearing beam on the second floor three points method to complete the 'pack The Installation and install the cooling plate.

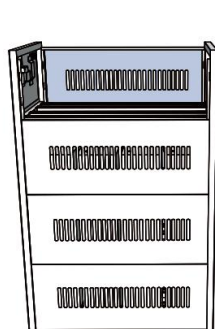

5

According to 4 points, 3 points method Don't finish three, four levels of electricity ChiZu installation. Then good electrical Pool tank to host connection.

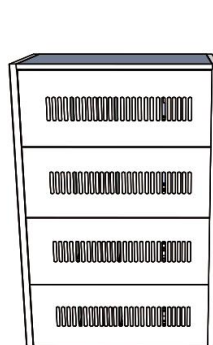

6

The final check on the back cover Top cover plate.

Angle C - 40 and non-standard Angle battery cabinet series:

Name of the component:

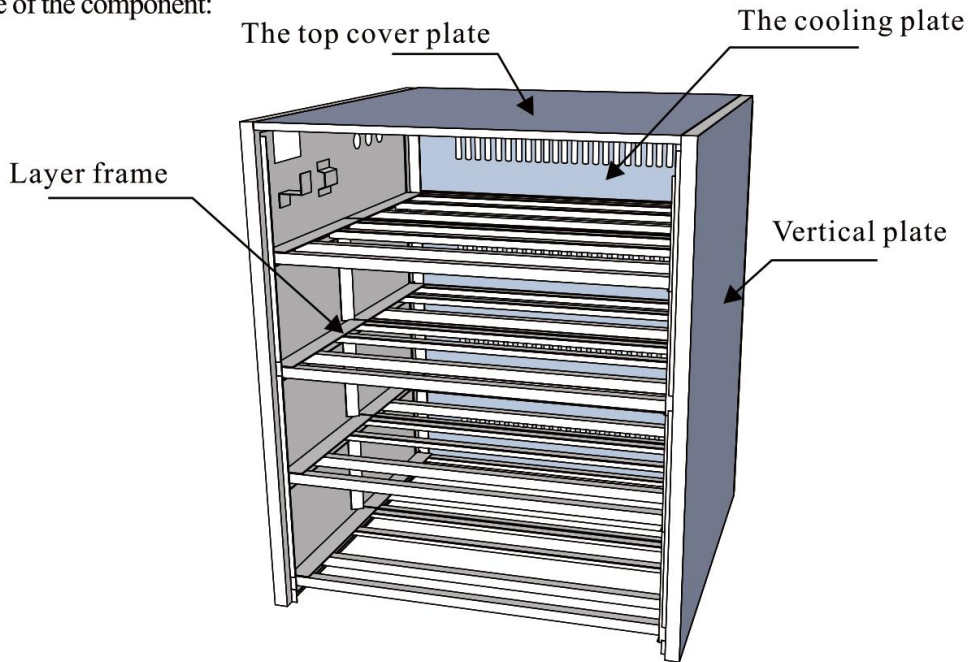

Installation instructions:

C-40legend

1

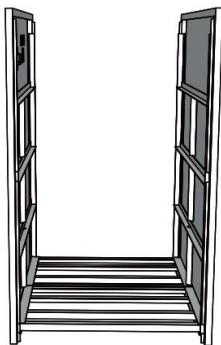

First take out 2 pieces of plate, leave 1 (or 2) insert the bottom angle of layer frame The bearing steel in the bayonet as a fixed.

2

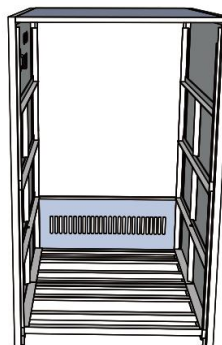

Install the bottom left (or right), a cooling plate, and then cover the top cover plate, adjust cabinet put oneself in another's position of the diagonal line, make cabinet put oneself in another's position is flat and level.

3



Installed at the bottom of a set of batteries in accordance with the requirements of using connected battery line, install the left or the right another cooling plate, and then pick up the top cover plate.

4

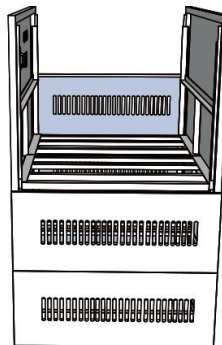

Install two layers of frame according to the 3 points method to complete the installation of the battery and install the cooling plate.

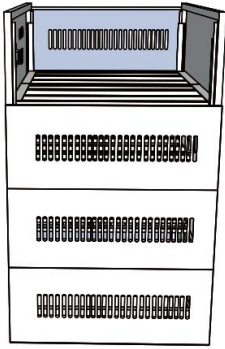

5

According to 4 points, 3 points method Don't finish three, four levels of electricity chizu installation. Then good electrical Pool tank to host connection.

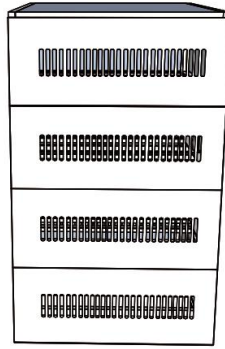

6

The final check on the backcover top cover plate.

(pictures listed in this manual are for reference only, product specifications and appearance are subject to change without prior notice)

Certificate Of Approval

The product was checked and approved by.

Inspector -----

Production
Batch Number -----