

21700867	DATA SHEET	
Valid from: 26.07.2024	EPIC® DATA SPE-6 PC M-M (L*m) CT001	

Description

- Pre-assembled Ethernet cable; SPE straight plug to SPE straight plug
- This data sheet is also valid for other lengths. Other lengths are available on request.



Product variants

Item number	Article description	Length (L*) [m]
21700867	EPIC® DATA SPE-6 PC M-M 0.3m CT001	0,3
21700868	EPIC® DATA SPE-6 PC M-M 0.5m CT001	0,5
21700869	EPIC® DATA SPE-6 PC M-M 1m CT001	1
21700870	EPIC® DATA SPE-6 PC M-M 1.5m CT001	1,5
21700871	EPIC® DATA SPE-6 PC M-M 2m CT001	2
21700872	EPIC® DATA SPE-6 PC M-M 3m CT001	3
21700873	EPIC® DATA SPE-6 PC M-M 5m CT001	5
21700874	EPIC® DATA SPE-6 PC M-M 10m CT001	10

General characteristics, Assembly

Cable diameter	4.0 mm
Number of cores	2
Outer jacket	TPE
Outer jacket, colour	black, similar
Mating cycles, SPE connectors	1000

General characteristic values, cable

AWG	26 AWG
Conductor, outer diameter	approx. 0.52 mm
wire, material	Copper wire, tinned
Core insulation, outer diameter	approx. 1.5 mm
Core insulation, material	PP
Wire colours	white, blue
	Aluminium-laminated film on the outside
Shielding	above: Copper mesh, tinned, Coverage ≥ 90 %

Creator: STKU3/PDP Released: IVSE1/PDP	Document: DB21700867EN Version: 01	Page 1 from 3
---	---------------------------------------	---------------

21700867	DATA SHEET	
Valid from: 26.07.2024	EPIC® DATA SPE-6 PC M-M (L*m) CT001	

Electrical properties of the cable at 20 °C

Conductor resistance	≤ 130 Ω/km
Insulation resistance, specific resistance	≥ 100 MΩ*km
Impedance in differential mode	100 Ω ± 5 Ω
Signal propagation time	< 6 ns/m
Test voltage, wire-wire	1000 V
Test voltage, wire shield	2500 V

Mechanical and thermal properties of the cable

Temperature range	-40 °C to +105 °C
-------------------	-------------------

General characteristic values, SPE connectors

Coding	SPE
Protection class	IP 20
Rated voltage max.	60 V
Current carrying capacity at 40°C	4 A
Ambient temperature	-25 °C to +85 °C
Insulation resistance	≥ 500 MΩ

Materials, SPE connectors

Contacts, base material	Copper alloy
Contacts, surface	Au
Plug-in unit	PA
Shielding	Stainless steel, tin-plated
Housing	PPS
Kink protection/strain relief	PVC

Standards

Product standard, SPE connectors	IEC 63171-6
----------------------------------	-------------

Creator: STKU3/PDP Released: IVSE1/PDP	Document: DB21700867EN Version: 01	Page 2 from 3
---	---------------------------------------	---------------

21700867	DATA SHEET	
Valid from: 26.07.2024	EPIC® DATA SPE-6 PC M-M (L*m) CT001	

Technical drawings

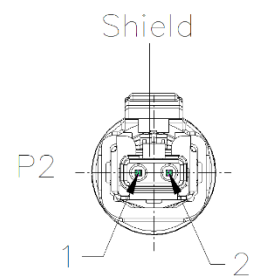
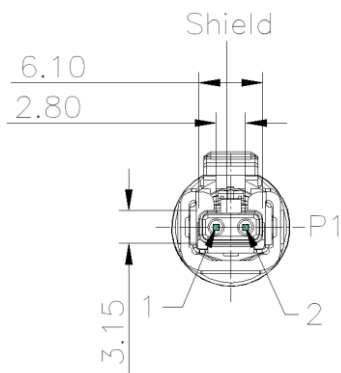
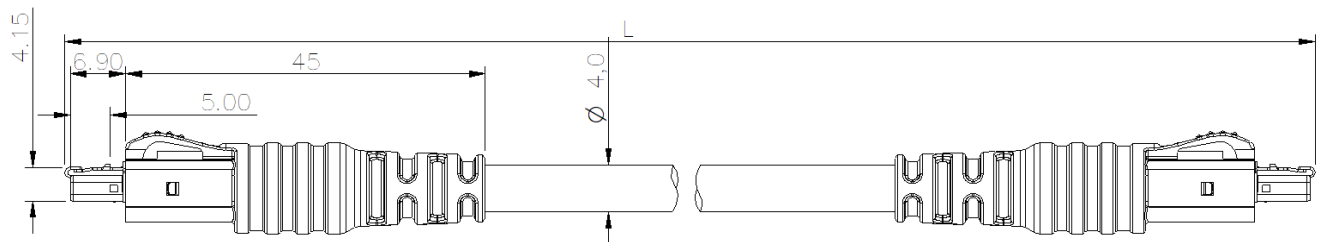
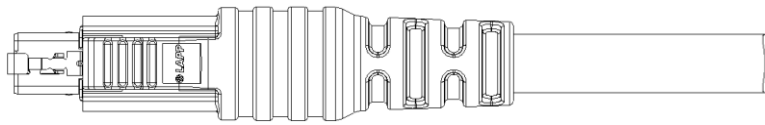

PIN Assignment

P1	Color	AWG	Wire Cutting (mm)	P2
1	Blue	#26 Cable		1
2	White			2
Shell	Braid			Shell

Areas of application

Automation, mechanical and plant engineering

Remark

The photographs are not to scale and are not detailed images of the respective products.

Creator: STKU3/PDP Released: IVSE1/PDP	Document: DB21700867EN Version: 01	Page 3 from 3
---	---------------------------------------	---------------