

Technical data sheet

Internal corner SLL IE2070

Item number: 6132243



Internal corner as a fitting for changing the direction of the skirting trunking.
Internal corner for snapping on to the base to conceal cuts.



PVC Polyvinylchloride

Master data

Item number	6132243
Type	SLL IE2070 rws
Description 1	Internal corner
Description 2	SL-L 20x70 9010
Manufacturer	OBO
Colour	Pure white; RAL 9010
Material	Polyvinylchloride
Smallest sales unit	10
Unit of quantity	Piece
Weight	1.42 kg
Weight unit	kg/100 pc.
CO2 Footprint (GWP) Cradle-to-Gate	0,036 kg CO2e / 1 Piece

Technical data sheet

Internal corner SLL IE2070

Item number: 6132243



Dimensions

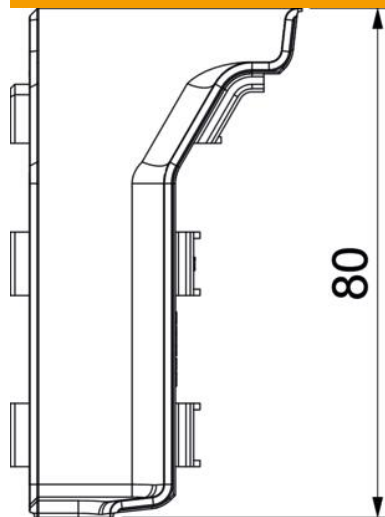

Length	46 mm
Width	46 mm
Height	80 mm

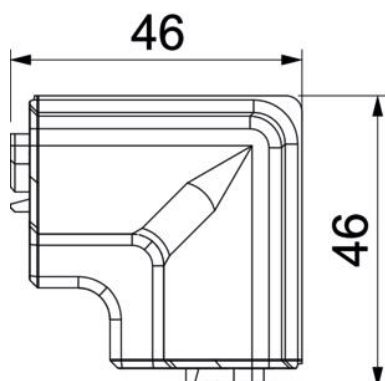

Technical data

Version for	Hood fitting
Decoration	Without
Cover sealing lip	Wall/floor
Halogen-free	no
With carpet strip	no
Protection rating	IP40
Protection rating IK code	IK06
Permitted temperature range, max.	60 °C
Permitted temperature range, min.	-5 °C
Angle range, min.	90 mm