

REVISION HISTORY			
REV	DESCRIPTION	DATE	APPROVED

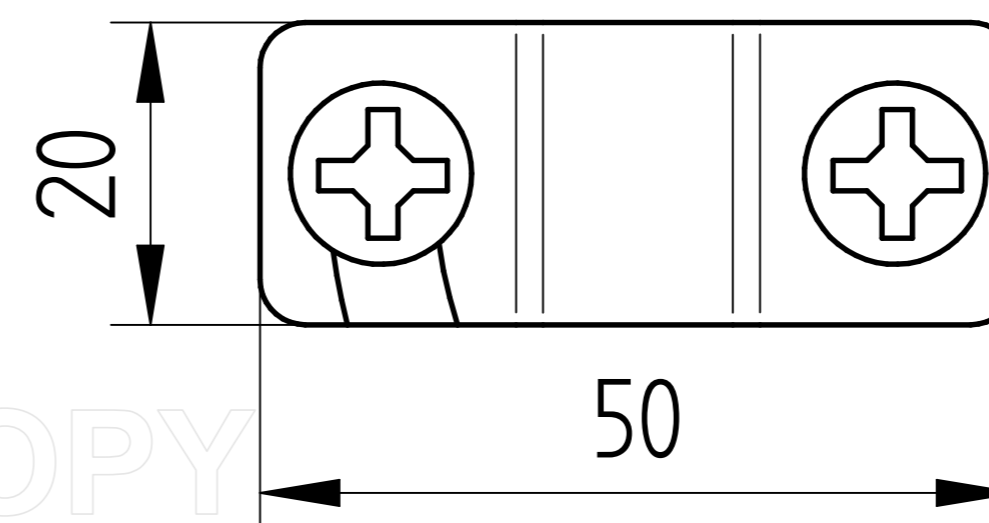
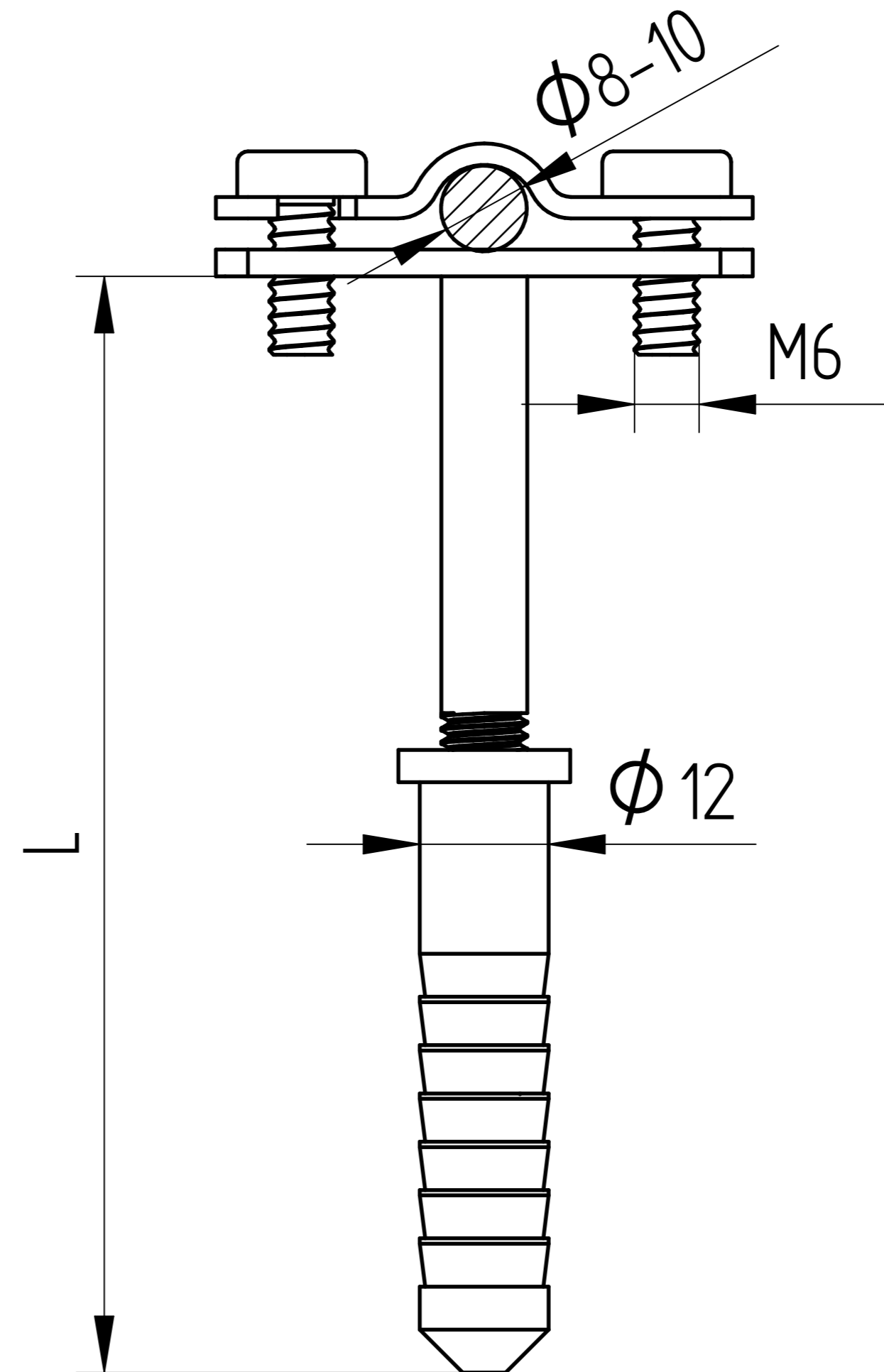

	NAME	DATE	Solid Edge	
DRAWN	Gromtor	09/02/22	TITLE	
CHECKED				
ENG APPR				
MGR APPR				
UNLESS OTHERWISE SPECIFIED DIMENSIONS ARE IN MILLIMETERS ANGLES ±XX° 2 PL ±XXX 3 PL ±XXXX			SIZE A2	DWG NO
			FILE NAME: 311112.dft	REV
			SCALE:	WEIGHT:
			SHEET 1 OF 1	

SOLID EDGE ACADEMIC COPY