

ONTEC S



IDEALNY DO POWIERZCHNI BIUROWYCH – DIODY LED,
DO KORYTARZY – DZIĘKI OPTYCE SOCZEWKOWEJ

Dzięki swojej prostej, minimalistycznej formie i szczelnej obudowie IP65 seria opraw ONTEC S może być wykorzystana w niemal każdym środowisku użytkowym. Od nowoczesnych pomieszczeń typu open space do zawilgoconych garaży wielkopowierzchniowych. Dzięki wykorzystaniu najwyższej jakości źródeł światła oprawa uzyskuje doskonałe parametry fluorescencyjne. W zależności od użytej optyki, oprawa może być wykorzystana do oświetlania wielkich powierzchni biurowych oraz długich korytarzy. Prosty kształt umożliwia zastosowanie dyfuzora, czyniąc z niej dwustronną oprawę oświetlenia awaryjnego.

PERFECT FOR OFFICE SPACES WITH THE LED DIODES
AND FOR CORRIDORS WITH LENTICULAR OPTICS

Due to its simple, minimalistic design and IP65 protection level, the ONTEC S series can be applied in almost every facility – from modern open space buildings to large, exposed to moisture garages. Since the fitting is equipped with the highest quality light sources, it maintains excellent fluorescent performance. Depending on the optics applied, the fitting can lighten both large office spaces and long corridors. Its simple design allows the use of a diffuser, turning it into a double-sided emergency lighting fitting.



^ Oświetlenie antypaniczne
Antypanic lighting

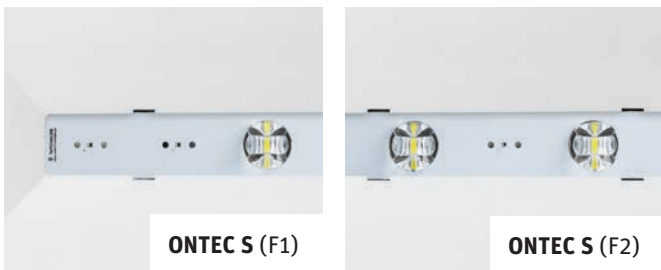
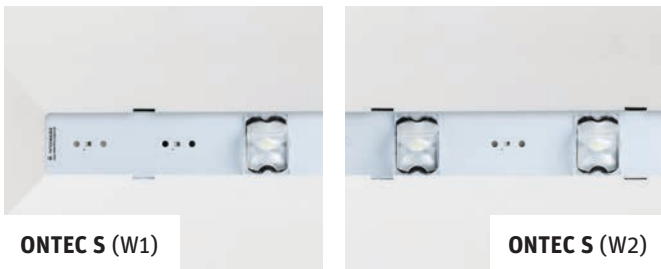

^ Oświetlenie drogi ewakuacji
Evacuation road lighting



^ ONTEC S (E1)
Jednostronna oprawa oświetlenia
ewakuacyjnego i awaryjnego
One-sided emergency and
evacuation lighting fitting



ONTEC S >
Montaż natynkowy
Surfaced mounting



< **ONTEC S**
Montaż wpuszczany
Recessed mounting



< **ONTEC S**
Wersja M1
M1 version





^ ONTEC S

Zgodny z PN-EN 1838
According to standard
PN-EN 1838

Źródło światła Light source	LED
Zastosowanie Application	M1,M2,M5: oświetlenie antypaniczne / antipanic lighting, E1: wyznaczenie kierunku ewakuacji (znak ewakuacji) / evacuation road direction (evacuation sign) W1,W2: oświetlenie drogi ewakuacji / evacuation road lighting C1,C2,F1,F2: oświetlenie drogi ewakuacji / evacuation road lighting
Testowanie Testing	Test ręczny, test automatyczny, centralny monitoring, centralna bateria Manual test, autotest, central monitoring, central battery
Zasilanie Power supply	210 - 250 V AC / 50 - 60HZ
Zasilanie - CB Power supply - CB	210 - 250 V AC / 50 - 60HZ 186 - 254 V DC
Stopień szczelności Protection type	IP65
Klasa izolacji Isolation class	II
Materiał Material	obudowa / housing: PC/ABS klosz / cover: PC przezroczysty / transparent dyfuzor / diffuser: PMMA
Kolor obudowy Housing colour	<input type="checkbox"/> RAL 9003  kolor specjalny / special colour
Tryb pracy Mode	M/NM
Autonomia Autonomy	3h
Zakres temperatury pracy Temperature range	t_a 10 ÷ 40°C (ST, AT, DATA) t_a -15 ÷ 40°C (COLD) t_a -15 ÷ 55°C (CB)
Normy Standards	PN-EN 60598-1, PN-EN 60598-2-22, PN-EN 61347-2-13, PN-EN 61347-1, PN-EN 55015, PN-EN 61000-3-2, PN-EN 62031, PN-EN 62471

ONTEC S M1, M2, M5

oświetlenie antypaniczne
antipanic lighting

Wymiary [mm]
Dimensions [mm]

269

144

40

Montaż
Mounting

Akcesoria
Accessories

27,5 x 4,5 x 15 [cm]

Ilość opakowań:
quantity of boxes: 700 szt.

800 1200

Wysokość montażu h (m) Mounting height h (m)	Maks. dystans ściana/oprawa [m] Max. distance wall/fitting [m]				Maks. dystans oprawa/oprawa [m] Max. distance fitting/fitting [m]				Maks. dystans oprawa/oprawa [m] Max. distance fitting/fitting [m]				Maks. dystans oprawa/ściana [m] Max. distance fitting/wall [m]			
	M1 7 LED ST/AT/DATA CB		M2 14 LED ST/AT/DATA CB		M1 7 LED ST/AT/DATA CB		M2 14 LED ST/AT/DATA CB		M1 7 LED ST/AT/DATA CB		M2 14 LED ST/AT/DATA CB		M1 7 LED ST/AT/DATA CB		M2 14 LED ST/AT/DATA CB	
3 h	-	-	3 h	-	3 h	-	-	-	3 h	-	-	-	-	3 h	-	-
2.5	3,2	3,6	3,7	3,8	8,0	8,7	9,0	9,2	8,0	8,7	9,0	9,2	3,2	3,6	3,7	3,8
3.0	3,5	4,0	4,0	4,2	8,6	9,5	9,6	10,1	8,6	9,5	9,6	10,1	3,5	4,0	4,0	4,2
4.0	3,6	4,2	4,3	4,6	9,7	11,0	11,4	11,6	9,7	11,0	11,4	11,6	3,6	4,2	4,3	4,6
5.0	3,7	4,3	4,6	4,7	10,5	12,1	12,5	12,9	10,5	12,1	12,5	12,8	3,7	4,3	4,6	4,7
6.0	3,6	4,4	4,7	4,8	11,2	12,8	13,4	13,7	11,2	12,8	13,4	13,7	3,6	4,4	4,7	4,8
7.0	3,4	4,5	4,8	4,9	11,5	13,5	14,1	14,4	11,5	13,5	14,1	14,4	3,4	4,5	4,8	4,9
8.0	2,4	4,5	4,8	4,9	11,7	14,0	14,5	14,7	11,7	14,0	14,5	14,7	2,4	4,5	4,8	4,9
9.0	1,8	3,7	4,5	4,6	11,6	14,3	14,8	15,0	11,6	14,3	14,8	15,0	1,8	3,7	4,5	4,6
10.0	-	3,4	4,0	4,1	-	14,4	15,2	15,4	-	14,4	15,2	15,4	-	3,4	4,0	4,1

ONTEC S M1 >

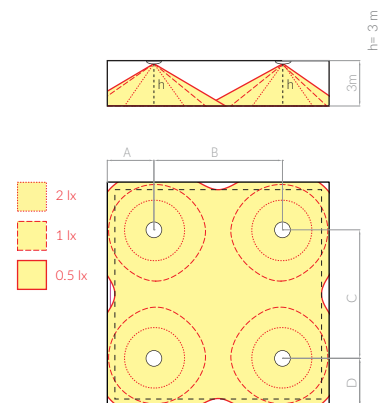
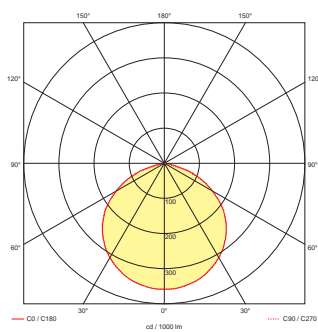

ONTEC S M2 >

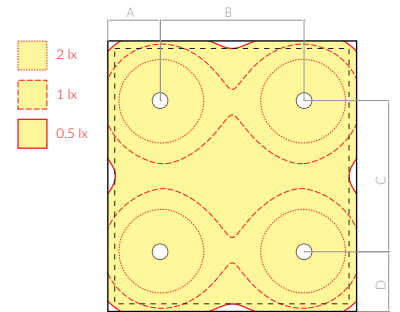
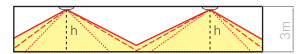
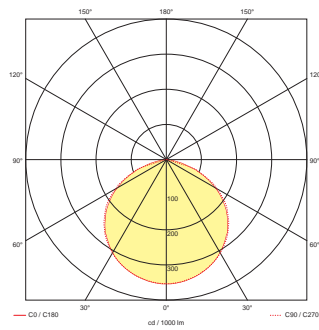

h=3m

Wysokość montażu h (m)
Mounting height h (m)

Maks. dystans ściana/oprawa [m]
Max. distance wall/fitting [m]



	M5 5W	
	ST/AT/DATA	CB
1h/3h	-	-
2.5	4.5	4.4
3.0	4.9	4.7
4.0	5.4	5.3
5.0	5.8	5.6
6.0	6.1	5.8
7.0	6.2	6.0
8.0	6.4	6.2
9.0	6.3	6.1
10.0	6.2	6.0

Maks. dystans oprawa/oprawa [m]
Max. distance fitting/fitting [m]

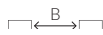

	M5 5W	
	ST/AT/DATA	CB
1h/3h	-	-
11.0	10.6	-
12.1	11.9	-
13.9	13.6	-
15.5	15.3	-
16.9	16.2	-
17.8	17.2	-
18.7	17.7	-
19.4	18.6	-
20.1	19.1	-

Maks. dystans oprawa/oprawa [m]
Max. distance fitting/fitting [m]

	M5 5W	
	ST/AT/DATA	CB
1h/3h	-	-
11.0	10.6	-
12.1	11.9	-
13.9	13.6	-
15.5	15.3	-
16.9	16.2	-
17.8	17.2	-
18.7	17.7	-
19.4	18.6	-
20.1	19.1	-

Maks. dystans oprawa/ściana [m]
Max. distance fitting/wall [m]

	M5 5W	
	ST/AT/DATA	CB
1h/3h	-	-
4.5	4.4	-
4.9	4.7	-
5.4	5.3	-
5.8	5.6	-
6.1	5.8	-
6.2	6.0	-
6.4	6.2	-
6.3	6.1	-
6.2	6.0	-

ONTEC S M5 >

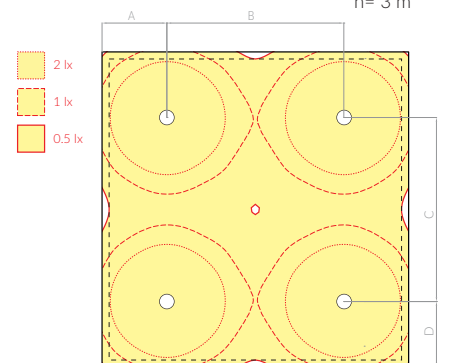
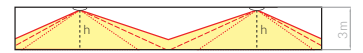
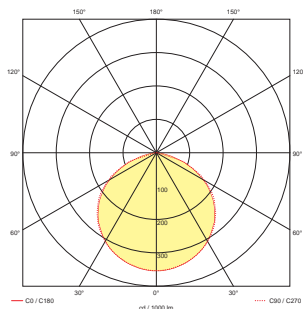

Typ Type	Model Model	Źródło światła Light source	Czas Time	Tryb pracy Mode	Strumień Luminous flux
ST - TEST RĘCZNY / MANUAL TEST [S]					
ONTEC S	M1 301 ST	1W / 7xLED	3h	M	193 lm / 128 lm
ONTEC S	M2 102 ST	2W / 14xLED	1h	M	235 lm / 218 lm
ONTEC S	M2 302 ST	2W / 14xLED	3h	M	235 lm / 218 lm
ONTEC S	M5 105 ST	5W / 5xLED	1h	M	243 lm / 522 lm
ONTEC S	M5 305 ST	5W / 5xLED	3h	M	243 lm / 522 lm
ONTEC S	M2 102 COLD ST	2W / 14xLED	1h	M/NM	250 lm / 250 lm
ONTEC S	M2 302 COLD ST	2W / 14xLED	3h	M/NM	235 lm / 218 lm
ONTEC S	M5 105 COLD ST	5W / 5xLED	1h	M/NM	243 lm / 522 lm
ONTEC S	M5 205 COLD ST	5W / 5xLED	2h	M/NM	243 lm / 522 lm
AT - TEST AUTOMATYCZNY / SELFTTEST (AUTOTEST) [P]					
ONTEC S	M1 301 AT	1W / 7xLED	3h	M	193 lm / 128 lm
ONTEC S	M2 102 AT	2W / 14xLED	1h	M	235 lm / 218 lm
ONTEC S	M2 302 AT	2W / 14xLED	3h	M	235 lm / 218 lm
ONTEC S	M5 105 AT	5W / 5xLED	1h	M	243 lm / 522 lm
ONTEC S	M5 305 AT	5W / 5xLED	3h	M	243 lm / 522 lm
ONTEC S	M2 102 COLD AT	2W / 14xLED	1h	M/NM	250 lm / 250 lm
ONTEC S	M2 302 COLD AT	2W / 14xLED	3h	M/NM	235 lm / 218 lm
ONTEC S	M5 105 COLD AT	5W / 5xLED	1h	M/NM	243 lm / 522 lm
ONTEC S	M5 205 COLD AT	5W / 5xLED	2h	M/NM	243 lm / 522 lm
DATA - TEST CENTRALNY AUTOMATYCZNY (MONITORING) / AUTOMATIC CENTRAL TEST (MONITORING) [ER or PRN]					
ONTEC S	M1 301 DATA	1W / 7xLED	3h	M	193 lm / 128 lm
ONTEC S	M2 102 DATA	2W / 14xLED	1h	M	235 lm / 218 lm
ONTEC S	M2 302 DATA	2W / 14xLED	3h	M	235 lm / 218 lm
ONTEC S	M5 105 DATA	5W / 5xLED	1h	M	243 lm / 522 lm
ONTEC S	M5 305 DATA	5W / 5xLED	3h	M	243 lm / 522 lm
ONTEC S	M2 102 COLD DATA	2W / 14xLED	1h	M/NM	250 lm / 250 lm
ONTEC S	M2 302 COLD DATA	2W / 14xLED	3h	M/NM	235 lm / 218 lm
ONTEC S	M5 105 COLD DATA	5W / 5xLED	1h	M/NM	243 lm / 522 lm
ONTEC S	M5 205 COLD DATA	5W / 5xLED	2h	M/NM	243 lm / 522 lm
CB - CENTRALNA BATERIA / CENTRAL BATTERY [ER or PRN]					
ONTEC S	M1 01 CBm	1W / 7xLED	-	-	193 lm / 193 lm
ONTEC S	M2 02 CBm	2W / 14xLED	-	-	235 lm / 235 lm
ONTEC S	M5 05 CBm	5W / 5xLED	-	-	470 lm / 470 lm

NM - praca awaryjna / non maintained

M - praca sieciowo-awaryjna / maintained

CBm - do centralnej baterii / to central battery

m - 1 bez modułu adresowego / 1 with no addressable module

2 moduł adresowy v1 / 2 addressable module v1

3 moduł adresowy v3 / 3 addressable module v2

ONTEC S E1 wyznaczanie kierunku ewakuacji (znak ewakuacji) evacuation road direction (evacuation sign)

<p>Wymiary [mm] Dimensions [mm]</p>	<p>Montaż Mounting</p> <p>27,5 x 4,5 x 15 [cm]</p> <p>Ilość opakowań: quantity of boxes: 700 szt.</p>	<p>Akcesoria Accessories</p>
---	---	----------------------------------

wymiary piktogramu
dimensions of pictogram: 246 x 123 mm

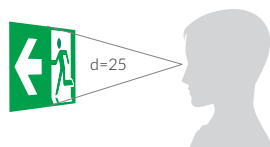

Piktogramy do opraw oświetlenia ewakuacyjnego, zgodnie z normą PN-EN ISO 7010
Pictograms for evacuation lighting fittings - according to PN-EN ISO 7010





Typ Type	Model Model	Źródło światła Light source	Czas Time	Tryb pracy Mode	Strumień Luminous flux
ST - TEST RĘCZNY / MANUAL TEST [S]					
ONTEC S	E1P 101 ST	2,5 W / 14xLED	1h	M/NM	>200 cd / m ²
ONTEC S	E1P 301 ST	2,5 W / 14xLED	3h	M/NM	>200 cd / m ²
ONTEC S	E1P 101 COLD ST	2,5 W / 14xLED	1h	M/NM	>200 cd / m ²
ONTEC S	E1P 301 COLD ST	2,5 W / 14xLED	3h	M/NM	>200 cd / m ²
AT - TEST AUTOMATYCZNY / SELFTEST (AUTOTEST) [P]					
ONTEC S	E1P 101 AT	2,5 W / 14xLED	1h	M/NM	>200 cd / m ²
ONTEC S	E1P 301 AT	2,5 W / 14xLED	3h	M/NM	>200 cd / m ²
ONTEC S	E1P 101 COLD AT	2,5 W / 14xLED	1h	M/NM	>200 cd / m ²
ONTEC S	E1P 301 COLD AT	2,5 W / 14xLED	3h	M/NM	>200 cd / m ²
DATA - TEST CENTRALNY AUTOMATYCZNY (MONITORING) / AUTOMATIC CENTRAL TEST (MONITORING) [ER or PRN]					
ONTEC S	E1P 101 DATA	2,5 W / 14xLED	1h	M/NM	>200 cd / m ²
ONTEC S	E1P 301 DATA	2,5 W / 14xLED	3h	M/NM	>200 cd / m ²
ONTEC S	E1P 101 COLD DATA	2,5 W / 14xLED	1h	M/NM	>200 cd / m ²
ONTEC S	E1P 301 COLD DATA	2,5 W / 14xLED	3h	M/NM	>200 cd / m ²
CB - CENTRALNA BATERIA / CENTRAL BATTERY [ER or PRN]					
ONTEC S	E1P01 CBm	2,5 W / 14xLED	-	-	>200 cd / m ²

NM - praca awaryjna / non maintained
M - praca sieciowo-awaryjna / maintained
CBm - do centralnej baterii / to central battery

m - 1 bez modułu adresowego / 1 with no addressable module
2 moduł adresowy v1 / 2 addressable module v1
3 moduł adresowy v3 / 3 addressable module v3

ONTEC S C1,C2 oświetlenie drogi ewakuacji evacuation road lighting

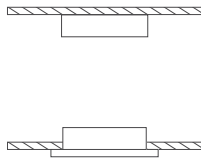
<p>Wymiary [mm] Dimensions [mm]</p>  <p style="text-align: center; margin-top: 10px;">  27,5 x 4,5 x 15 [cm]  Ilość opakowań: quantity of boxes: 700 szt. </p>	<p>Montaż Mounting</p> 
---	---

ONTEC S C1 ▼



Wysokość montażu h (m) Mounting height h (m)	Maks. dystans ściana/oprawa [m] Max. distance wall/fitting [m]				Maks. dystans oprawa/oprawa [m] Max. distance fitting/fitting [m]			
	C1 1W ST/AT/DATA CB		C2 2W ST/AT/DATA CB		C1 1W ST/AT/DATA CB		C2 2W ST/AT/DATA CB	
	1h/3h	-	1h/3h	-	1h/3h	-	1h/3h	-
2,5	7,5	7,5	8,7	8,7	17,0	17,0	19,1	19,1
3,0	8,3	8,3	9,8	9,8	19,2	19,2	21,8	21,8
4,0	7,6	7,6	11,3	11,3	22,0	22,0	26,8	26,8
5,0	4,8	4,8	10,9	10,9	21,2	21,2	30,2	30,2
6,0	3,9	3,9	10,2	10,2	18,6	18,6	32,0	32,0
7,0	3,6	3,6	8,3	8,3	14,4	14,4	31,8	31,8
8,0	-	-	6,1	6,1	-	-	29,9	29,9
9,0	-	-	5,3	5,3	-	-	25,3	25,3
10,0	-	-	5,1	5,1	-	-	20,0	20,0

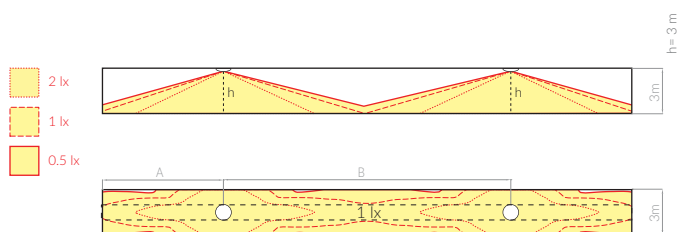
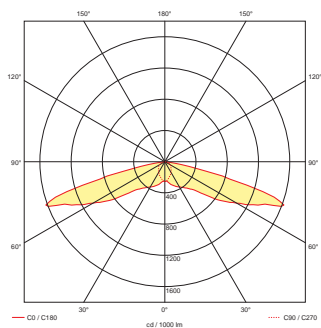

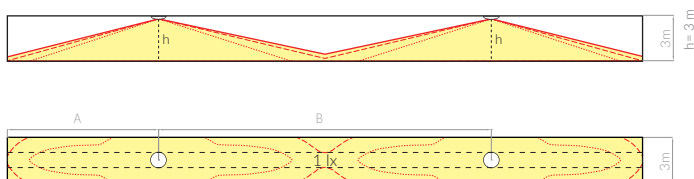
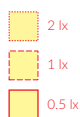
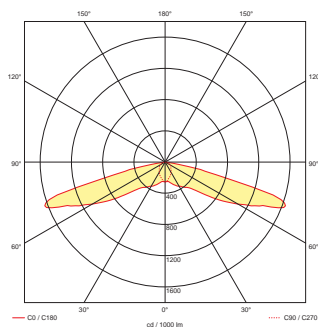
ONTEC S C2

Typ Type	Model Model	Źródło światła Light source	Czas Time	Tryb pracy Mode	Strumień Luminous flux
ST - TEST RĘCZNY / MANUAL TEST [S]					
ONTEC S	C1 302 ST	2,5W / 1xLED	3h	M/NM	204 lm / 204 lm
ONTEC S	C2 105 ST	5W / 2xLED	1h	M/NM	246 lm / 410 lm
ONTEC S	C2 305 ST	5W / 2xLED	3h	M/NM	246 lm / 410 lm
ONTEC S	C1 302 COLD ST	2,5W / 1xLED	3h	M/NM	204 lm / 204 lm
ONTEC S	C2 105 COLD ST	5W / 2xLED	1h	M/NM	246 lm / 410 lm
ONTEC S	C2 205 COLD ST	5W / 2xLED	2h	M/NM	246 lm / 410 lm
AT - TEST AUTOMATYCZNY / SELFTEST (AUTOTEST) [P]					
ONTEC S	C1 302 AT	2,5W / 1xLED	3h	M/NM	204 lm / 204 lm
ONTEC S	C2 105 AT	5W / 2xLED	1h	M/NM	246 lm / 410 lm
ONTEC S	C2 305 AT	5W / 2xLED	3h	M/NM	246 lm / 410 lm
ONTEC S	C1 302 COLD AT	2,5W / 1xLED	3h	M/NM	204 lm / 204 lm
ONTEC S	C2 105 COLD AT	5W / 2xLED	1h	M/NM	246 lm / 410 lm
ONTEC S	C2 205 COLD AT	5W / 2xLED	2h	M/NM	246 lm / 410 lm
DATA - TEST CENTRALNY AUTOMATYCZNY (MONITORING) / AUTOMATIC CENTRAL TEST (MONITORING) [ER or PRN]					
ONTEC S	C1 302 DATA	2,5W / 1xLED	3h	M/NM	204 lm / 204 lm
ONTEC S	C2 105 DATA	5W / 2xLED	1h	M/NM	246 lm / 410 lm
ONTEC S	C2 305 DATA	5W / 2xLED	3h	M/NM	246 lm / 410 lm
ONTEC S	C1 302 COLD DATA	2,5W / 1xLED	3h	M/NM	204 lm / 204 lm
ONTEC S	C2 105 COLD DATA	5W / 2xLED	1h	M/NM	246 lm / 410 lm
ONTEC S	C2 205 COLD DATA	5W / 2xLED	2h	M/NM	246 lm / 410 lm
CB - CENTRALNA BATERIA / CENTRAL BATTERY [ER or PRN]					
ONTEC S	C1 02 CBm	2,5W / 1xLED	-	-	204 lm / 204 lm
ONTEC S	C2 05 CBm	5W / 2xLED	-	-	410 lm / 410 lm

NM - praca awaryjna / non maintained
M - praca sieciowo-awaryjna / maintained
CBm - do centralnej baterii / to central battery

m - 1 bez modułu adresowego / 1 with no addressable module
2 moduł adresowy v1 / 2 addressable module v1
3 moduł adresowy v3 / 3 addressable module v2

ONTEC S F1, F2 oświetlenie drogi ewakuacji evacuation road lighting

Wymiary [mm]
Dimensions [mm]

269

40

144

27,5 x 4,5 x 15 [cm]

Ilość opakowań:
quantity of boxes: 700 szt.

Montaż
Mounting

Maks. dystans ściana/oprawa [m]
Max. distance wall/fitting [m]

Wysokość montażu h (m)
Mounting height h (m)



h	F1 1W ST/AT/DATA CB		F2 2W ST/AT/DATA CB	
	1h/3h	-	1h/3h	-
2,5	4,4	4,4	5,7	5,7
3,0	4,8	4,8	6,1	6,1
4,0	5,4	5,4	6,9	6,9
5,0	5,7	5,7	7,4	7,4
6,0	6,2	6,2	8,0	8,0
7,0	6,4	6,4	8,2	8,2
8,0	6,4	6,4	8,7	8,7
9,0	6,3	6,3	8,7	8,7
10,0	6,3	6,3	8,9	8,9

Maks. dystans oprawa/oprawa [m]
Max. distance fitting/fitting [m]



h	F1 1W ST/AT/DATA CB		F2 2W ST/AT/DATA CB	
	1h/3h	-	1h/3h	-
10,8	10,8	-	13,5	13,5
11,8	11,8	-	14,7	14,7
13,1	13,1	-	16,8	16,8
14,3	14,3	-	18,7	18,7
15,2	15,2	-	19,8	19,8
16,1	16,1	-	20,5	20,5
16,6	16,6	-	21,7	21,7
17,3	17,3	-	22,6	22,6
17,6	17,6	-	23,2	23,2

ONTEC S F1 ▾

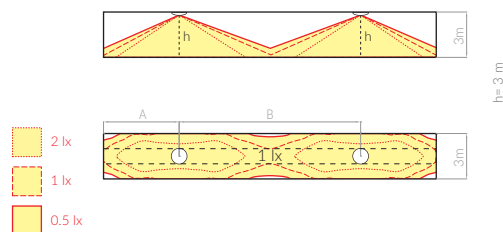
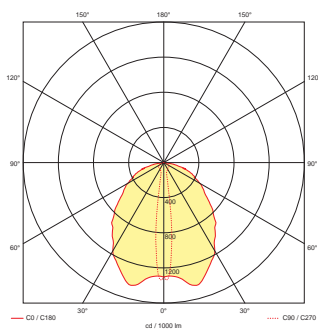

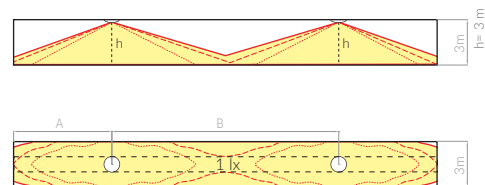
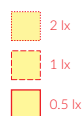
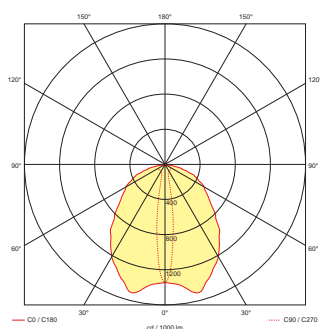
ONTEC S F2

Typ Type	Model Model	Źródło światła Light source	Czas Time	Tryb pracy Mode	Strumień Luminous flux
ST - TEST RĘCZNY / MANUAL TEST [S]					
ONTEC S	F1 302 ST	2,5 W / 1xLED	3h	M/NM	205 lm / 205 lm
ONTEC S	F2 105 ST	5W / 2xLED	1h	M/NM	241 lm / 398 lm
ONTEC S	F2 305 ST	5W / 2xLED	3h	M/NM	241 lm / 398 lm
ONTEC S	F1 302 COLD ST	2,5 W / 1xLED	3h	M/NM	205 lm / 205 lm
ONTEC S	F2 105 COLD ST	5W / 2xLED	1h	M/NM	241 lm / 398 lm
ONTEC S	F2 205 COLD ST	5W / 2xLED	2h	M/NM	241 lm / 398 lm
AT - TEST AUTOMATYCZNY / SELFTEST (AUTOTEST) [P]					
ONTEC S	F1 302 AT	2,5 W / 1xLED	3h	M/NM	205 lm / 205 lm
ONTEC S	F2 105 AT	5W / 2xLED	1h	M/NM	241 lm / 398 lm
ONTEC S	F2 305 AT	5W / 2xLED	3h	M/NM	241 lm / 398 lm
ONTEC S	F1 302 COLD AT	2,5 W / 1xLED	3h	M/NM	205 lm / 205 lm
ONTEC S	F2 105 COLD AT	5W / 2xLED	1h	M/NM	241 lm / 398 lm
ONTEC S	F2 205 COLD AT	5W / 2xLED	2h	M/NM	241 lm / 398 lm
DATA - TEST CENTRALNY AUTOMATYCZNY (MONITORING) / AUTOMATIC CENTRAL TEST (MONITORING) [ER or PRN]					
ONTEC S	F1 302 DATA	2,5 W / 1xLED	3h	M/NM	205 lm / 205 lm
ONTEC S	F2 105 DATA	5W / 2xLED	1h	M/NM	241 lm / 398 lm
ONTEC S	F2 305 DATA	5W / 2xLED	3h	M/NM	241 lm / 398 lm
ONTEC S	F1 302 COLD DATA	2,5 W / 1xLED	3h	M/NM	205 lm / 205 lm
ONTEC S	F2 105 COLD DATA	5W / 2xLED	1h	M/NM	241 lm / 398 lm
ONTEC S	F2 205 COLD DATA	5W / 2xLED	2h	M/NM	241 lm / 398 lm
CB - CENTRALNA BATERIA / CENTRAL BATTERY [ER or PRN]					
ONTEC S	F1 02 CBm	2,5W / 1xLED	-	-	205 lm / 205 lm
ONTEC S	F2 05 CBm	5W / 2xLED	-	-	398 lm / 398 lm

NM - praca awaryjna / non maintained
M - praca sieciowo-awaryjna / maintained
CBm - do centralnej baterii / to central battery

m - 1 bez modułu adresowego / 1 with no addressable module
2 moduł adresowy v1 / 2 addressable module v1
3 moduł adresowy v3 / 3 addressable module v2

ONTEC S W1, W2 oświetlenie drogi ewakuacji evacuation road lighting

Wymiary [mm]
Dimensions [mm]

269

144

40

Montaż
Mounting

27,5 x 4,5 x 15 [cm]

Ilość opakowań:
quantity of boxes: 700 szt.

Wysokość montażu h (m)
Mounting height h (m)

Maks. dystans ściana/oprawa [m]
Max. distance wall/fitting [m]

h	W1 1W ST/AT/DATA CB		W2 2W ST/AT/DATA CB	
	1h/3h	-	1h/3h	-
2.5	3,3	3,3	4,0	4,0
3.0	3,5	3,5	4,3	4,3
4.0	3,4	3,4	4,6	4,6
5.0	2,8	2,8	4,6	4,6
6.0	2,0	2,0	4,2	4,2
7.0	0,7	0,7	3,6	3,6
8.0	-	-	2,5	2,5
9.0	-	-	1,2	1,2
10.0	-	-	0,5	0,5

Maks. dystans oprawa/oprawa [m]
Max. distance fitting/fitting [m]

h	W1 1W ST/AT/DATA CB		W2 2W ST/AT/DATA CB	
	1h/3h	-	1h/3h	-
8,0	8,0	-	9,5	9,5
8,6	8,6	-	10,2	10,2
9,3	9,3	-	11,4	11,4
9,6	9,6	-	12,5	12,5
8,5	8,5	-	13,0	13,0
7,4	7,4	-	13,0	13,0
-	-	-	12,1	12,1
-	-	-	10,9	10,9
-	-	-	8,4	8,4

ONTEC S W1

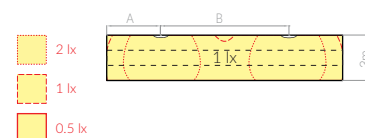
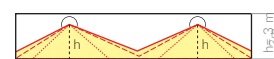
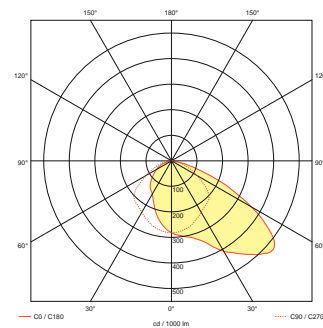

ONTEC S W2

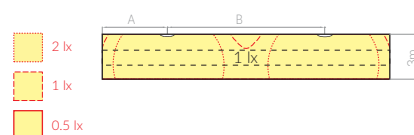
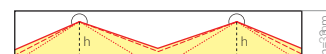
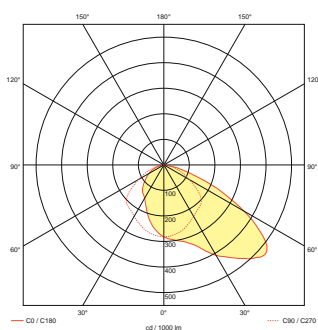

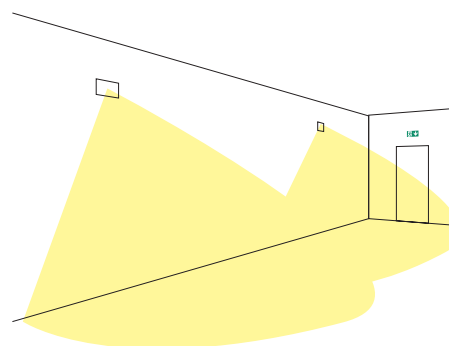
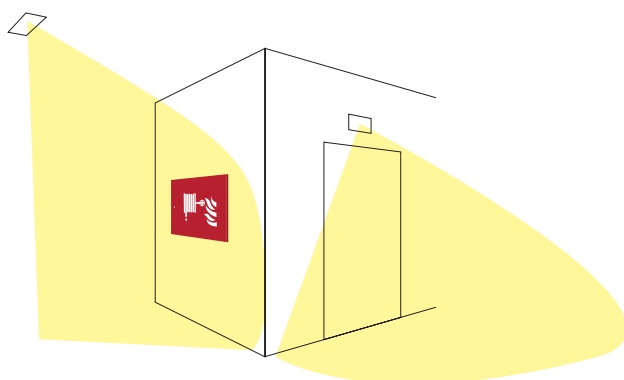
ZASTOSOWANIE ONTEC S W1, W2 ✓
THE USE OF ONTEC S W1, W2

Typ Type	Model	Źródło światła Light source	Czas Time	Tryb pracy Mode	Strumień Luminous flux
ST - TEST RĘCZNY / MANUAL TEST [S]					
ONTEC S	W1 302 ST	2,5 W / 1xLED	3h	M/NM	185 lm / 185 lm
ONTEC S	W2 105 ST	5W / 2xLED	1h	M/NM	213 lm / 351 lm
ONTEC S	W2 305 ST	5W / 2xLED	3h	M/NM	213 lm / 351 lm
ONTEC S	W1 302 COLD ST	2,5 W / 1xLED	3h	M/NM	185 lm / 185 lm
ONTEC S	W2 105 COLD ST	5W / 2xLED	1h	M/NM	213 lm / 351 lm
ONTEC S	W2 205 COLD ST	5W / 2xLED	2h	M/NM	213 lm / 351 lm
AT - TEST AUTOMATYCZNY / SELFTEST (AUTOTEST) [P]					
ONTEC S	W1 302 AT	2,5 W / 1xLED	3h	M/NM	185 lm / 185 lm
ONTEC S	W2 105 AT	5W / 2xLED	1h	M/NM	213 lm / 351 lm
ONTEC S	W2 305 AT	5W / 2xLED	3h	M/NM	213 lm / 351 lm
ONTEC S	W1 302 COLD AT	2,5 W / 1xLED	3h	M/NM	185 lm / 185 lm
ONTEC S	W2 105 COLD AT	5W / 2xLED	1h	M/NM	213 lm / 351 lm
ONTEC S	W2 205 COLD AT	5W / 2xLED	2h	M/NM	213 lm / 351 lm
DATA - TEST CENTRALNY AUTOMATYCZNY (MONITORING) / AUTOMATIC CENTRAL TEST (MONITORING) [ER or PRN]					
ONTEC S	W1 302 DATA	2,5 W / 1xLED	3h	M/NM	185 lm / 185 lm
ONTEC S	W2 105 DATA	5W / 2xLED	1h	M/NM	213 lm / 351 lm
ONTEC S	W2 305 DATA	5W / 2xLED	3h	M/NM	213 lm / 351 lm
ONTEC S	W1 302 COLD DATA	2,5 W / 1xLED	3h	M/NM	185 lm / 185 lm
ONTEC S	W2 105 COLD DATA	5W / 2xLED	1h	M/NM	213 lm / 351 lm
ONTEC S	W2 205 COLD DATA	5W / 2xLED	2h	M/NM	213 lm / 351 lm
CB - CENTRALNA BATERIA / CENTRAL BATTERY [ER or PRN]					
ONTEC S	W1 02 CBm	2,5 W / 1xLED	-	-	185 lm / 185 lm
ONTEC S	W2 05 CBm	5 W / 2xLED	-	-	351 lm / 351 lm

NM - praca awaryjna / non maintained
M - praca sieciowo-awaryjna / maintained
CBm - do centralnej baterii / to central battery

m - 1 bez modułu adresowego / 1 with no addressable module
2 moduł adresowy v1 / 2 addressable module v1
3 moduł adresowy v3 / 3 addressable module v2