

iTECH



IMPONUJĄCY OBSZAR ŚWIECENIA DZIĘKI TYLKO JEDNEJ OPRAWIE ZE ŹRÓDŁEM ŚWIATŁA POWER LED 2W/5W.

Pojedyncza oprawa IP65 może oświetlić obszar o powierzchni nawet 244 m², a wersji korytarzowej odległość między oprawami może wynosić nawet do 38 metrów. iTECH wpisany jest w doskonały kształt koła, komponuje się z każdym wnętrzem. Elektronika jest szczelnie zamknięta w obudowie, zabezpieczona przed wilgocią z zewnątrz. Wersja iTECH Z z dołączonym dyfuzorem i zwieszem, pełni funkcję oprawy ewakuacyjnej.

IMPRESSIVE ILLUMINATION AREA THANKS TO THE ONLY FITTING WITH 2W/5W POWER LED LIGHT SOURCE.

Self contained fitting with IP65 protection level was designed to lighten areas up to 244 m² and the distance between fittings may be up to 38 meters. iTECH has a perfect circular shape, which ensures that the fitting matches any interior style. Electronics are enclosed in a sealed housing and protected against humidity from the outside. The iTECH Z version with diffuser serves as the evacuation fitting.

✓ Oświetlenie antypaniczne
Antipanic lighting



iTECH M2



iTECH M5



iTECH S1



iTECH S2

✓ Oświetlenie drogi ewakuacji
Evacuation road lighting



iTECH C1



iTECH C2



iTECH F1



iTECH F2



iTECH W1



iTECH W2





COMARCH / Kraków



✓ **iTECH C2**

Oświetlenie drogi ewakuacji
Evacuation road lighting



∧ **Montaż natynkowy**
Surfaced mounting

✓ **iTECH C2**

Oświetlenie drogi ewakuacji
Evacuation road lighting



∧ **Montaż wpuszczany**
Recessed mounting

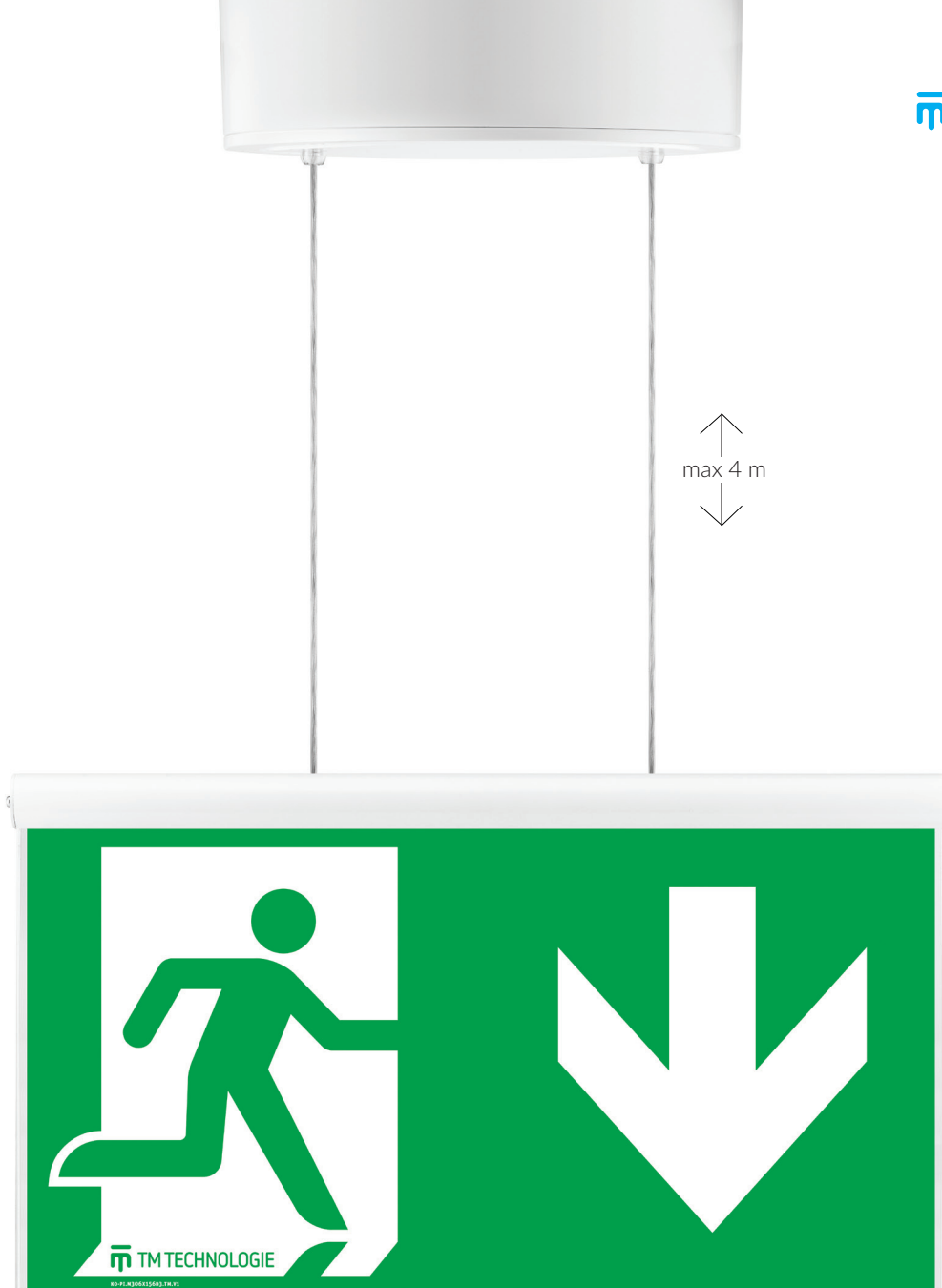

iTECH Z 

Zgodny z normą PN-EN 1838

According to standard PN-EN 1838

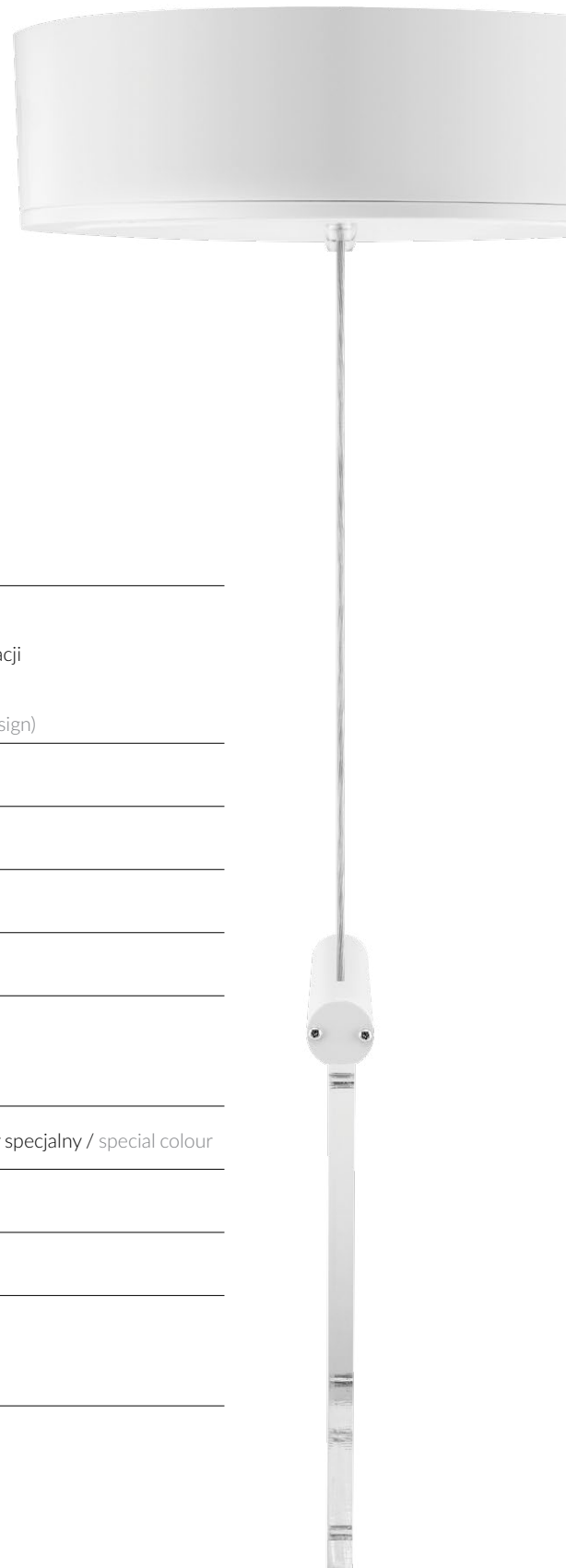

Podłączenie zasilania (DATA)

Power supply (DATA)

Źródło światła Light source	LED
Zastosowanie Application	iTECH M2, M5, S1, S2: oświetlenie antypaniczne / antipanic lighting iTECH C1, C2, F1, F2, W1, W2: oświetlenie drogi ewakuacji / evacuation road lighting iTECH Z: wyznaczenie kierunku ewakuacji (znak ewakuacji) / evacuation road direction (evacuation sign)
Zasilanie Power supply	230 V AC / 50 - 60Hz ± 10%
Zasilanie – CB Power supply – CB	230 V AC / 50 - 60Hz ± 10% 186 - 254 V DC
Stopień szczelności Protection type	IP65
Klasa izolacji Isolation class	II
Materiał Material	iTECH: obudowa / housing: PC/ABS klosz / cover: PC przezroczysty / transparent iTECH Z: obudowa / housing: PC/ABS + ALU dyfuzor / diffuser: PMMA
Kolor obudowy Housing colour	<input type="checkbox"/> RAL 9003 <input type="checkbox"/> RAL 7035 <input type="checkbox"/> RAL 9004 <input type="checkbox"/> kolor specjalny / special colour
Tryb pracy Mode	M/NM
Autonomia Autonomy	1h/3 h
Zakres temperatury pracy t_a Temperature range t_a	t_a 10°C ÷ +40°C COLD: t_a -15°C ÷ +40°C cb1: t_a -25°C ÷ +55°C cb2: t_a -15°C ÷ +40°C
Normy Standards	PN-EN 60598-1, PN-EN 60598-2-22, PN-EN 61347-2-13, PN-EN 61347-1, PN-EN 55015, PN-EN 61000-3-2, PN-EN 62031, PN-EN 62471

ITECH M2, M5 oświetlenie antypaniczne antipanic lighting

Wymiary [mm]
Dimensions [mm]

19,5 x 20 x 7 [cm]

Ilość opakowań:
quantity of boxes:
400 szt./pcs

180 cm
90 cm 120 cm

Montaż
Mounting

Akcesoria
Accessories

ITECH M2

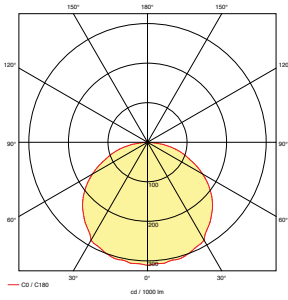

Wysokość montażu h (m) Mounting height h (m)	Maks. dystans ściana/oprawa [m] Max. distance wall/fitting [m]			Maks. dystans oprawa/oprawa [m] Max. distance fitting/fitting [m]			Maks. dystans oprawa/oprawa [m] Max. distance fitting/fitting [m]			Maks. dystans oprawa/ściana [m] Max. distance fitting/wall [m]			
	d0	d1	CB	d1	CB	d2	d2	CB	d3	d3	CB		
2,5	3,8	3,8	3,8	9,6	9,6	9,6	9,6	9,6	9,6	9,6	3,8	3,8	3,8
3,0	4,0	4,0	4,0	10,4	10,4	10,4	10,4	10,4	10,4	10,4	4,0	4,0	4,0
4,0	4,2	4,2	4,2	11,7	11,7	11,7	11,7	11,7	11,7	11,7	4,2	4,2	4,2
5,0	4,5	4,5	4,5	12,7	12,7	12,7	12,7	12,7	12,7	12,7	4,5	4,5	4,5
6,0	4,7	4,7	4,7	13,5	13,5	13,5	13,5	13,5	13,5	13,5	4,7	4,7	4,7
7,0	4,7	4,7	4,7	14,0	14,0	14,0	14,0	14,0	14,0	14,0	4,7	4,7	4,7
8,0	4,5	4,5	4,5	14,5	14,5	14,5	14,5	14,5	14,5	14,5	4,5	4,5	4,5
9,0	4,5	4,5	4,5	14,3	14,3	14,3	14,3	14,3	14,3	14,3	4,5	4,5	4,5
10,0	4,0	4,0	4,0	14,9	14,9	14,9	14,9	14,9	14,9	14,9	4,0	4,0	4,0

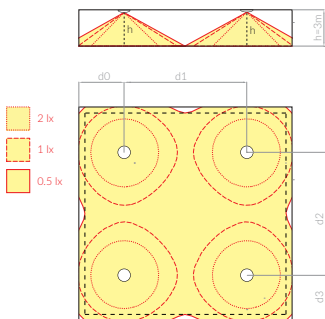

ZASTOSOWANIE ITECH M2, M5, S1, S2 THE USE OF RINO M2, M5, S1, S2

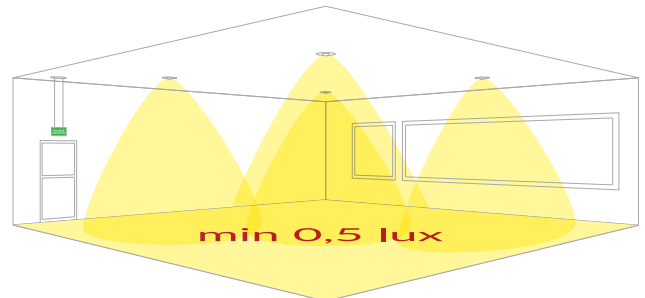

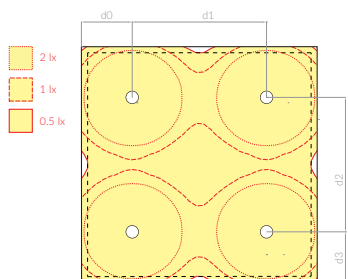
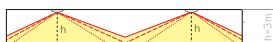
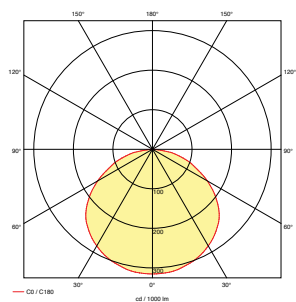
ITECH M5

Wysokość montażu h (m) Mounting height h (m)	Maks. dystans ściana/oprawa [m] Max. distance wall/fitting [m]			Maks. dystans oprawa/oprawa [m] Max. distance fitting/fitting [m]			Maks. dystans oprawa/oprawa [m] Max. distance fitting/fitting [m]			Maks. dystans oprawa/ściana [m] Max. distance fitting/wall [m]		
	1 h	3 h	CB	1 h	3 h	CB	1 h	3 h	CB	1 h	3 h	CB
2,5	4,6	4,6	4,6	11,2	11,2	11,2	11,2	11,2	11,2	4,6	4,6	4,6
3,0	5,1	5,1	5,1	12,5	12,5	12,5	12,5	12,5	12,5	5,1	5,1	5,1
4,0	5,7	5,7	5,7	13,9	13,9	13,9	13,9	13,9	13,9	5,7	5,7	5,7
5,0	5,9	5,9	5,9	15,4	15,4	15,4	15,4	15,4	15,4	5,9	5,9	5,9
6,0	6,6	6,6	6,6	16,2	16,2	16,2	16,2	16,2	16,2	6,6	6,6	6,6
7,0	6,7	6,7	6,7	17,4	17,4	17,4	17,4	17,4	17,4	6,7	6,7	6,7
8,0	6,5	6,5	6,5	18,2	18,2	18,2	18,2	18,2	18,2	6,5	6,5	6,5
9,0	6,4	6,4	6,4	19,5	19,5	19,5	19,5	19,5	19,5	6,4	6,4	6,4
10,0	6,4	6,4	6,4	19,9	19,9	19,9	19,9	19,9	19,9	6,4	6,4	6,4

Typ Type	Model Model	Źródło światła Light source	Czas Time	Tryb pracy Mode	Strumień w pracy dziennej luminous flux in day mode	Strumień w pracy awaryjnej luminous flux in emergency mode
ST - TEST RĘCZNY / MANUAL TEST [S]						
ITECH	M2 302 ST	2W / 1xLED	3h	M/NM	245 lm	245 lm
ITECH	M2 102 COLD ST	2W / 1xLED	1h	M/NM	245 lm	245 lm
ITECH	M2 302 COLD ST	2W / 1xLED	3h	M/NM	245 lm	245 lm
ITECH	M5 105 ST	5W / 2xLED	1h	M/NM	223 lm	475 lm
ITECH	M5 305 ST	5W / 2xLED	3h	M/NM	223 lm	475 lm
ITECH	M5 105 COLD ST	5W / 2xLED	1h	M/NM	223 lm	475 lm
AT - TEST AUTOMATYCZNY / SELFTEST (AUTOTEST) [P]						
ITECH	M2 302 AT	2W / 1xLED	3h	M/NM	245 lm	245 lm
ITECH	M2 102 COLD AT	2W / 1xLED	1h	M/NM	245 lm	245 lm
ITECH	M2 302 COLD AT	2W / 1xLED	3h	M/NM	245 lm	245 lm
ITECH	M5 105 AT	5W / 2xLED	1h	M/NM	223 lm	475 lm
ITECH	M5 305 AT	5W / 2xLED	3h	M/NM	223 lm	475 lm
ITECH	M5 105 COLD AT	5W / 2xLED	1h	M/NM	223 lm	475 lm
DATA - TEST CENTRALNY AUTOMATYCZNY (MONITORING) / AUTOMATIC CENTRAL TEST (MONITORING) [ER or PRN]						
ITECH	M2 302 DATA (DATA 2)	2W / 1xLED	3h	M/NM	245 lm	245 lm
ITECH	M2 102 COLD DATA (DATA 2)	2W / 1xLED	1h	M/NM	245 lm	245 lm
ITECH	M2 302 COLD DATA (DATA 2)	2W / 1xLED	3h	M/NM	245 lm	245 lm
ITECH	M5 105 ST DATA (DATA 2)	5W / 2xLED	1h	M/NM	223 lm	475 lm
ITECH	M5 305 ST DATA (DATA 2)	5W / 2xLED	3h	M/NM	223 lm	475 lm
ITECH	M5 105 COLD DATA (DATA 2)	5W / 2xLED	1h	M/NM	223 lm	475 lm
CB - CENTRALNA BATERIA / CENTRAL BATTERY [ER or PRN]						
ITECH	M2 02 CBm	2W / 1xLED	-	-	245 lm	245 lm
ITECH	M5 05 CBm	5W / 2xLED	-	-	475 lm	475 lm

NM - praca awaryjna / non maintained
M - praca sieciowo-awaryjna / maintained

ITECH S1, S2

oświetlenie antypaniczne
antipanic lighting

Wymiary [mm]
Dimensions [mm]

19,5 x 20 x 7 [cm]
Ilość opakowań:
quantity of boxes:
400 szt./pcs

Montaż
Mounting

Aksesoria
Accessories

ITECH S1

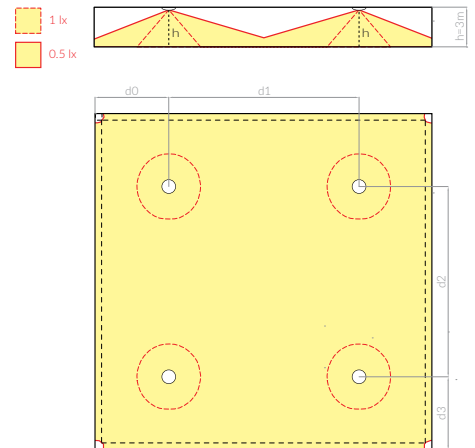
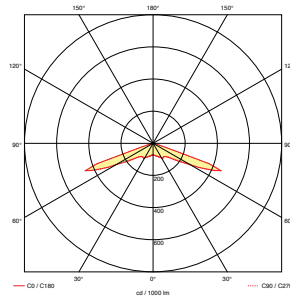

Wysokość montażu h (m) Mounting height h (m)	Maks. dystans ściana/oprawa [m] Max. distance wall/fitting [m]			Maks. dystans oprawa/oprawa [m] Max. distance fitting/fitting [m]			Maks. dystans oprawa/oprawa [m] Max. distance fitting/fitting [m]			Maks. dystans oprawa/ściana [m] Max. distance fitting/wall [m]		
	1h	3h	CB	1h	3h	CB	1h	3h	CB	1h	3h	CB
2,5	6,2	6,2	6,2	13,2	13,2	13,2	13,2	13,2	13,2	6,2	6,2	6,2
3,0	6,4	6,4	6,4	14,4	14,4	14,4	14,4	14,4	14,4	6,4	6,4	6,4
4,0	3,2	3,2	3,2	14,6	14,6	14,6	14,6	14,6	14,6	3,2	3,2	3,2

iTECH S2 >

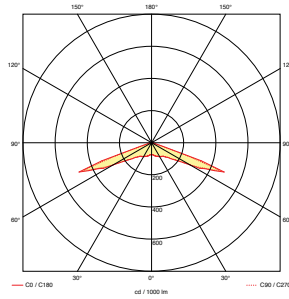

- 2 lx
- 1 lx
- 0.5 lx

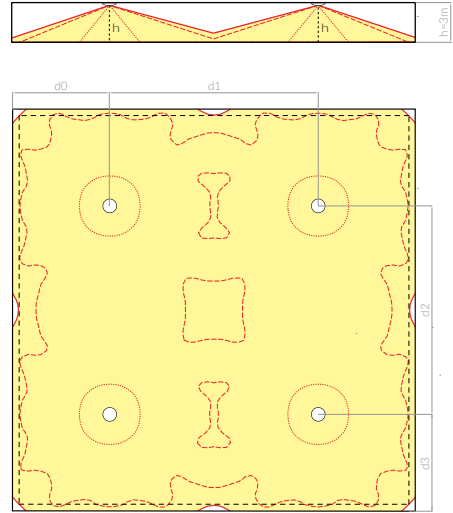

Wysokość montażu h (m) Mounting height h (m)	Maks. dystans ściana/oprawa [m] Max. distance wall/fitting [m]			Maks. dystans oprawa/oprawa [m] Max. distance fitting/fitting [m]			Maks. dystans oprawa/oprawa [m] Max. distance fitting/fitting [m]			Maks. dystans oprawa/ściana [m] Max. distance fitting/wall [m]		
	d0			d1			d2			d3		
	1h	3h	CB	1h	3h	CB	1h	3h	CB	1h	3h	CB
2.5	6.5	6.5	6.5	13.7	13.7	13.7	13.7	13.7	13.7	6.5	6.5	6.5
3.0	7.5	7.5	7.5	15.8	15.8	15.8	15.8	15.8	15.8	7.5	7.5	7.5
4.0	8.9	8.9	8.9	18.8	18.8	18.8	18.8	18.8	18.8	8.9	8.9	8.9

Typ Type	Model Model	Źródło światła Light source	Czas Time	Tryb pracy Mode	Strumień w pracy dziennej luminous flux in day mode	Strumień w pracy awaryjnej luminous flux in emergency mode
ST - TEST RĘCZNY / MANUAL TEST [S]						
iTECH	S1 302 ST	2W / 1xLED	3h	M/NM	222 lm	222 lm
iTECH	S1 102 COLD ST	2W / 1xLED	1h	M/NM	222 lm	222 lm
iTECH	S1 302 COLD ST	2W / 1xLED	3h	M/NM	222 lm	222 lm
iTECH	S2 105 ST	5W / 2xLED	1h	M/NM	196 lm	418 lm
iTECH	S2 305 ST	5W / 2xLED	3h	M/NM	196 lm	418 lm
iTECH	S2 105 COLD ST	5W / 2xLED	1h	M/NM	196 lm	418 lm
AT - TEST AUTOMATYCZNY / SELFTEST (AUTOTEST) [P]						
iTECH	S1 302 AT	2W / 1xLED	3h	M/NM	222 lm	222 lm
iTECH	S1 102 COLD AT	2W / 1xLED	1h	M/NM	222 lm	222 lm
iTECH	S1 302 COLD AT	2W / 1xLED	3h	M/NM	222 lm	222 lm
iTECH	S2 105 AT	5W / 2xLED	1h	M/NM	196 lm	418 lm
iTECH	S2 305 AT	5W / 2xLED	3h	M/NM	196 lm	418 lm
iTECH	S2 105 COLD AT	5W / 2xLED	1h	M/NM	196 lm	418 lm
DATA - TEST CENTRALNY AUTOMATYCZNY (MONITORING) / AUTOMATIC CENTRAL TEST (MONITORING) [ER or PRN]						
iTECH	S1 302 DATA (DATA 2)	2W / 1xLED	3h	M/NM	222 lm	222 lm
iTECH	S1 102 COLD DATA (DATA 2)	2W / 1xLED	1h	M/NM	222 lm	222 lm
iTECH	S1 302 COLD DATA (DATA 2)	2W / 1xLED	3h	M/NM	222 lm	222 lm
iTECH	S2 105 DATA (DATA 2)	5W / 2xLED	1h	M/NM	196 lm	418 lm
iTECH	S2 305 DATA (DATA 2)	5W / 2xLED	3h	M/NM	196 lm	418 lm
iTECH	S2 105 COLD DATA (DATA 2)	5W / 2xLED	1h	M/NM	196 lm	418 lm
CB - CENTRALNA BATERIA / CENTRAL BATTERY [ER or PRN]						
iTECH	S1 02 CBm	2W / 1xLED	-	-	222 lm	222 lm
iTECH	S2 05 CBm	5W / 2xLED	-	-	418 lm	418 lm

NM - praca awaryjna / non maintained
M - praca sieciowo-awaryjna / maintained

ITECH C1, C2 oświetlenie drogi ewakuacji

Evacuation road lighting

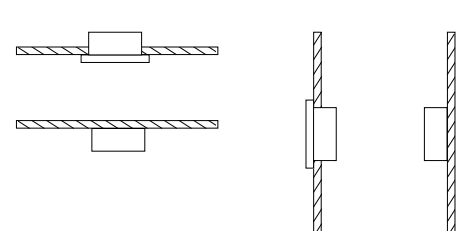
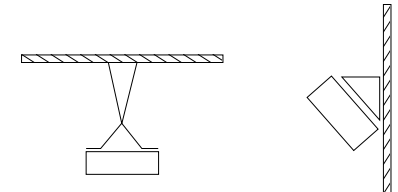
<p>Wymiary [mm] Dimensions [mm]</p>  <p>19,5 x 20 x 7 [cm] Ilość opakowań: quantity of boxes: 400 szt./pcs</p> <p>180 cm 80 cm 120 cm</p>	<p>Montaż Mounting</p> 
	<p>Aksesoria Accessories</p> 

ITECH C1 >

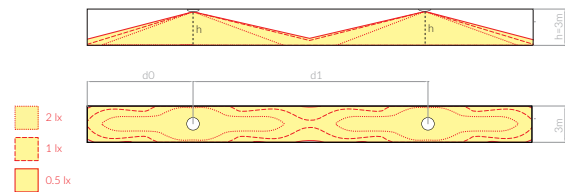
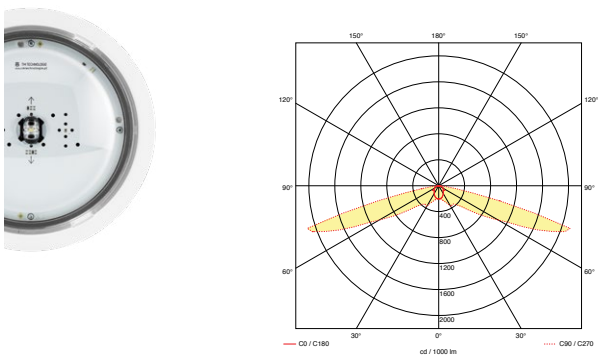

ZASTOSOWANIE ITECH C1, C2

THE USE OF ITECH C1, C2

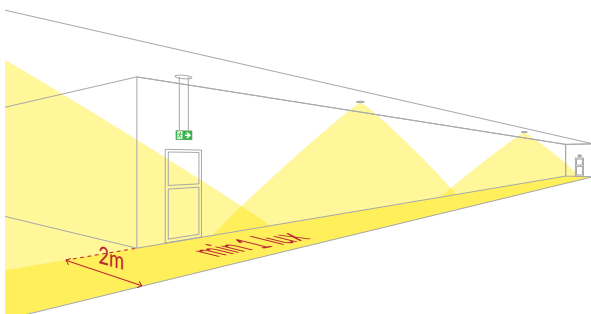

Wysokość montażu h (m) Mounting height h (m)	Maks. dystans ściana/ oprawa [m] Max. distance wall/ fitting [m]			Maks. dystans oprawa/ oprawa [m] Max. distance fitting/ fitting [m]		
	1h	3h	CB	1h	3h	CB
2,5	8.3	8.3	8.3	18.4	18.4	18.4
3,0	9.3	9.3	9.3	21.2	21.2	21.2
4,0	9.7	9.7	9.7	25.4	25.4	25.4
5,0	5.0	5.0	5.0	27.0	27.0	27.0
6,0	4.1	4.1	4.1	22.0	22.0	22.0

iTECH C2

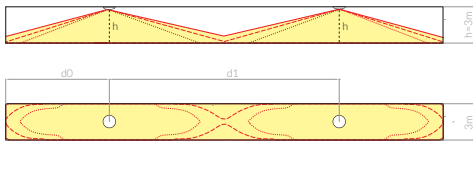
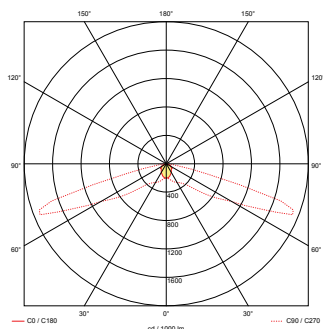

Wysokość montażu h (m) Mounting height h (m)	Maks. dystans ściana/oprawa [m] Max. distance wall/fitting [m]			Maks. dystans oprawa/oprawa [m] Max. distance fitting/fitting [m]		
	1h	3h	CB	1h	3h	CB
2,5	8,8	8,8	8,8	19,4	19,4	19,4
3,0	10,0	10,0	10,0	22,0	22,0	22,0
4,0	12,2	12,2	12,2	27,2	27,2	27,2
5,0	13,6	13,6	13,6	31,8	31,8	31,8
6,0	14,0	14,0	14,0	35,4	35,4	35,4
7,0	10,2	10,2	10,2	38,0	38,0	38,0
8,0	5,2	5,2	5,2	33	33	33
9,0	3,8	3,8	3,8	27	27	27

Typ Type	Model Model	Źródło światła Light source	Czas Time	Tryb pracy Mode	Strumień w pracy dziennej luminous flux in day mode	Strumień w pracy awaryjnej luminous flux in emergency mode
ST - TEST RĘCZNY / MANUAL TEST [S]						
iTECH	C1 302 ST	2W / 1xLED	3h	M/NM	215 lm	215 lm
iTECH	C1 102 COLD ST	2W / 1xLED	1h	M/NM	215 lm	215 lm
iTECH	C1 302 COLD ST	2W / 1xLED	3h	M/NM	215 lm	215 lm
iTECH	C2 105 ST	5W / 2xLED	1h	M/NM	204 lm	433 lm
iTECH	C2 305 ST	5W / 2xLED	3h	M/NM	204 lm	433 lm
iTECH	C2 105 COLD ST	5W / 2xLED	1h	M/NM	204 lm	433 lm
AT - TEST AUTOMATYCZNY / SELFTEST (AUTOTEST) [P]						
iTECH	C1 302 AT	2W / 1xLED	3h	M/NM	215 lm	215 lm
iTECH	C1 102 COLD AT	2W / 1xLED	1h	M/NM	215 lm	215 lm
iTECH	C1 302 COLD AT	2W / 1xLED	3h	M/NM	215 lm	215 lm
iTECH	C2 105 AT	5W / 2xLED	1h	M/NM	204 lm	433 lm
iTECH	C2 305 AT	5W / 2xLED	3h	M/NM	204 lm	433 lm
iTECH	C2 105 COLD AT	5W / 2xLED	1h	M/NM	204 lm	433 lm
DATA - TEST CENTRALNY AUTOMATYCZNY (MONITORING) / AUTOMATIC CENTRAL TEST (MONITORING) [ER or PRN]						
iTECH	C1 302 DATA (DATA 2)	2W / 1xLED	3h	M/NM	215 lm	215 lm
iTECH	C1 102 COLD DATA (DATA 2)	2W / 1xLED	1h	M/NM	215 lm	215 lm
iTECH	C1 302 COLD DATA (DATA 2)	2W / 1xLED	3h	M/NM	215 lm	215 lm
iTECH	C2 105 DATA (DATA 2)	5W / 2xLED	1h	M/NM	204 lm	433 lm
iTECH	C2 305 DATA (DATA 2)	5W / 2xLED	3h	M/NM	204 lm	433 lm
iTECH	C2 105 COLD DATA (DATA 2)	5W / 2xLED	1h	M/NM	204 lm	433 lm
CB - CENTRALNA BATERIA / CENTRAL BATTERY [ER or PRN]						
iTECH	C1 02 CBm	2W / 1xLED	-	-	215 lm	215 lm
iTECH	C2 05 CBm	5W / 2xLED	-	-	433 lm	433 lm

NM – praca awaryjna / non maintained
M – praca sieciowo-awaryjna / maintained

ITECH F1, F2 oświetlenie drogi ewakuacji Evacuation road lighting

Wymiary [mm]
Dimensions [mm]

19,5 x 20 x 7 [cm]

Ilość opakowań:
quantity of boxes:
400 szt./pcs

80 cm 120 cm

Montaż
Mounting

Akcesoria
Accessories

ITECH F1 >

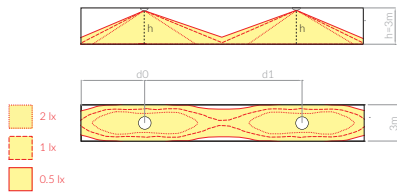
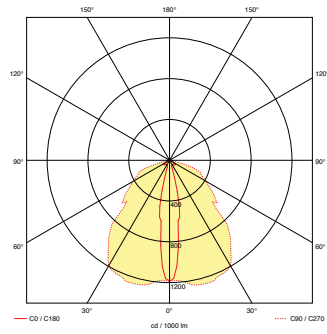

ZASTOSOWANIE ITECH F1, F2 v THE USE OF ITECH F1, F2

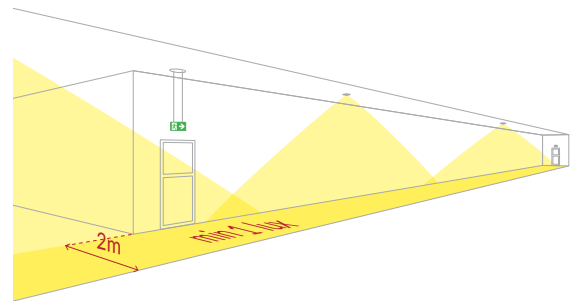

Wysokość montażu h (m) Mounting height h (m)	Maks. dystans ściana/ oprawa [m] Max. distance wall/ fitting [m]			Maks. dystans oprawa/ oprawa [m] Max. distance fitting/ fitting [m]		
	d0	d0	CB	d1	d1	CB
2,5	4,9	4,9	4,9	12,1	12,1	12,1
3,0	5,3	5,3	5,3	13,0	13,0	13,0
4,0	5,8	5,8	5,8	14,5	14,5	14,5
5,0	6,3	6,3	6,3	15,8	15,8	15,8
6,0	6,3	6,3	6,3	16,8	16,8	16,8
7,0	6,8	6,8	6,8	17,6	17,6	17,6
8,0	7,2	7,2	7,2	18	18	18
9,0	7,4	7,4	7,4	18,2	18,2	18,2
10,0	7,4	7,4	7,4	19	19	19

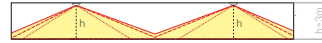
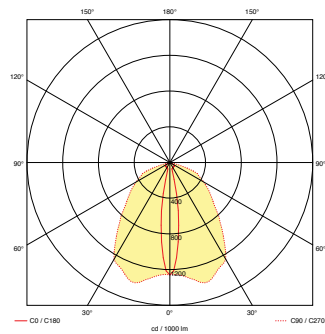
iTECH F2

Wysokość montażu h (m) Mounting height h (m)	Maks. dystans ściana/oprawa [m] Max. distance wall/fitting [m]			Maks. dystans oprawa/oprawa [m] Max. distance fitting/fitting [m]		
	1h	3h	CB	1h	3h	CB
2,5	6.0	6.0	6.0	14.0	14.0	14.0
3,0	6.4	6.4	6.4	15.6	15.6	15.6
4,0	7.2	7.2	7.2	17.8	17.8	17.8
5,0	7.8	7.8	7.8	19.4	19.4	19.4
6,0	8.4	8.4	8.4	20.8	20.8	20.8
7,0	8.7	8.7	8.7	22.0	22.0	22.0
8,0	9	9	9	23.2	23.2	23.2
9,0	9.3	9.3	9.3	24	24	24
10,0	9.6	9.6	9.6	24.6	24.6	24.6

Typ Type	Model Model	Źródło światła Light source	Czas Time	Tryb pracy Mode	Strumień w pracy dziennej luminous flux in day mode	Strumień w pracy awaryjnej luminous flux in emergency mode
ST - TEST RĘCZNY / MANUAL TEST [S]						
iTECH	F1 302 ST	2W / 1xLED	3h	M/NM	244 lm	244 lm
iTECH	F1 102 COLD ST	2W / 1xLED	1h	M/NM	244 lm	244 lm
iTECH	F1 302 COLD ST	2W / 1xLED	3h	M/NM	244 lm	244 lm
iTECH	F2 105 ST	5W / 2xLED	1h	M/NM	212 lm	452 lm
iTECH	F2 305 ST	5W / 2xLED	3h	M/NM	212 lm	452 lm
iTECH	F2 105 COLD ST	5W / 2xLED	1h	M/NM	212 lm	452 lm
AT - TEST AUTOMATYCZNY / SELFTTEST (AUTOTEST) [P]						
iTECH	F1 302 AT	2W / 1xLED	3h	M/NM	244 lm	244 lm
iTECH	F1 102 COLD AT	2W / 1xLED	1h	M/NM	244 lm	244 lm
iTECH	F1 302 COLD AT	2W / 1xLED	3h	M/NM	244 lm	244 lm
iTECH	F2 105 AT	5W / 2xLED	1h	M/NM	212 lm	452 lm
iTECH	F2 305 AT	5W / 2xLED	3h	M/NM	212 lm	452 lm
iTECH	F2 105 COLD AT	5W / 2xLED	1h	M/NM	212 lm	452 lm
DATA - TEST CENTRALNY AUTOMATYCZNY (MONITORING) / AUTOMATIC CENTRAL TEST (MONITORING) [ER or PRN]						
iTECH	F1 302 DATA (DATA 2)	2W / 1xLED	3h	M/NM	244 lm	244 lm
iTECH	F1 102 COLD DATA (DATA 2)	2W / 1xLED	1h	M/NM	244 lm	244 lm
iTECH	F1 302 COLD DATA (DATA 2)	2W / 1xLED	3h	M/NM	244 lm	244 lm
iTECH	F2 105 DATA (DATA 2)	5W / 2xLED	1h	M/NM	212 lm	452 lm
iTECH	F2 305 DATA (DATA 2)	5W / 2xLED	3h	M/NM	212 lm	452 lm
iTECH	F2 105 COLD DATA (DATA 2)	5W / 2xLED	1h	M/NM	212 lm	452 lm
CB - CENTRALNA BATERIA / CENTRAL BATTERY [ER or PRN]						
iTECH	F1 02 CBm	2W / 1xLED	-	-	244 lm	244 lm
iTECH	F2 05 CBm	5W / 2xLED	-	-	452 lm	452 lm

NM – praca awaryjna / non maintained
M – praca sieciowo-awaryjna / maintained

ITECH W1, W2 oświetlenie drogi ewakuacji

Evacuation road lighting

Wymiary [mm]
Dimensions [mm]

19,5 x 20 x 7 [cm]
Ilość opakowań:
quantity of boxes:
400 szt./pcs

180 cm
80 cm 120 cm

Montaż
Mounting

Aksesoria
Accessories

ITECH W1

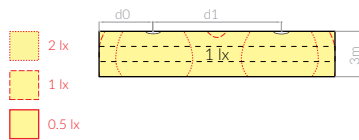
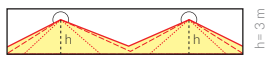
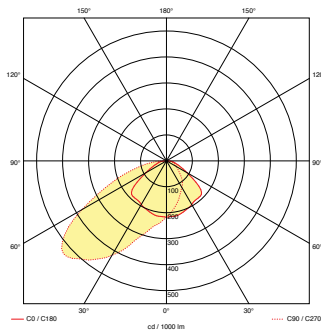

Wysokość montażu h (m)
Mounting height h (m)

Maks. dystans ściana/oprawa [m]
Max. distance wall/fitting [m]

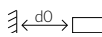

Maks. dystans oprawa/oprawa [m]
Max. distance fitting/fitting [m]

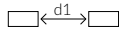

Wysokość montażu h (m) Mounting height h (m)	Maks. dystans ściana/oprawa [m] Max. distance wall/fitting [m]			Maks. dystans oprawa/oprawa [m] Max. distance fitting/fitting [m]		
	1h	3h	CB	1h	3h	CB
2.5	3.5	3.5	3.5	8.5	8.5	8.5
3.0	3.8	3.8	3.8	9.4	9.4	9.4
4.0	4.1	4.1	4.1	10.7	10.7	10.7
5.0	3.4	3.4	3.4	11.0	11.0	11.0
6.0	2.4	2.4	2.4	10.8	10.8	10.8

ZASTOSOWANIE ITECH W1, W2

THE USE OF ITECH W1, W2

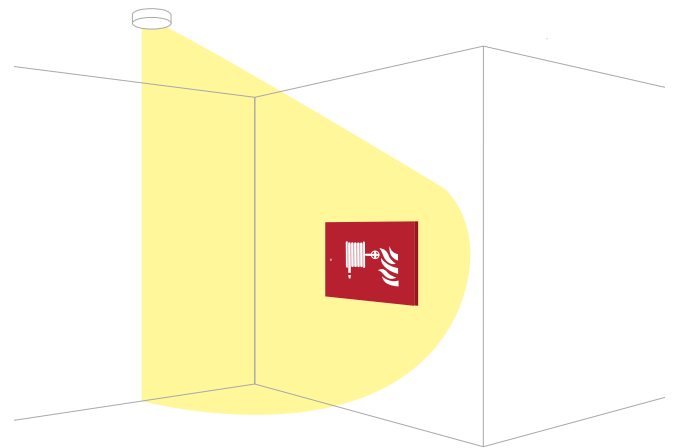

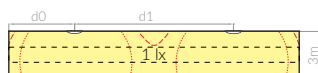
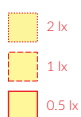
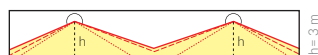
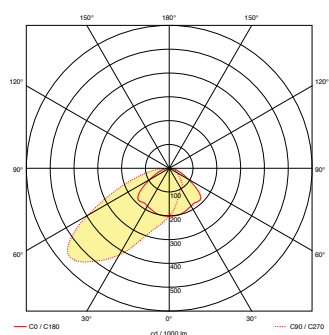
iTECH W2

Wysokość montażu h (m) Mounting height h (m)	Maks. dystans ściana/ oprawa [m] Max. distance wall/ fitting [m]			Maks. dystans oprawa/ oprawa [m] Max. distance fitting/ fitting [m]		
	1h	3h	CB	1h	3h	CB
2,5	4.4	4.4	4.4	10.2	10.2	10.2
3,0	4.8	4.8	4.8	11.2	11.2	11.2
4,0	5.5	5.5	5.5	13.0	13.0	13.0
5,0	5.8	5.8	5.8	14.4	14.4	14.4
6,0	5.7	5.7	5.7	15.4	15.4	15.4
7,0	4.6	4.6	4.6	15.8	15.8	15.8
8,0	3.5	3.5	3.5	15.2	15.2	15.2
9,0	3.5	3.5	3.5	15	15	15

Typ Type	Model Model	Źródło światła Light source	Czas Time	Tryb pracy Mode	Strumień w pracy dziennej luminous flux in day mode	Strumień w pracy awaryjnej luminous flux in emergency mode
ST - TEST RĘCZNY / MANUAL TEST [S]						
iTECH	W1 302 ST	2W / 1xLED	3h	M/NM	209 lm	209 lm
iTECH	W1 102 COLD ST	2W / 1xLED	1h	M/NM	209 lm	209 lm
iTECH	W1 302 COLD ST	2W / 1xLED	3h	M/NM	209 lm	209 lm
iTECH	W2 105 ST	5W / 2xLED	1h	M/NM	201 lm	427 lm
iTECH	W2 305 ST	5W / 2xLED	3h	M/NM	201 lm	427 lm
iTECH	W2 105 COLD ST	5W / 2xLED	1h	M/NM	201 lm	427 lm
AT - TEST AUTOMATYCZNY / SELFTEST (AUTOTEST) [P]						
iTECH	W1 302 AT	2W / 1xLED	3h	M/NM	209 lm	209 lm
iTECH	W1 102 COLD AT	2W / 1xLED	1h	M/NM	209 lm	209 lm
iTECH	W1 302 COLD AT	2W / 1xLED	3h	M/NM	209 lm	209 lm
iTECH	W2 105 AT	5W / 2xLED	1h	M/NM	201 lm	427 lm
iTECH	W2 305 AT	5W / 2xLED	3h	M/NM	201 lm	427 lm
iTECH	W2 105 COLD AT	5W / 2xLED	1h	M/NM	201 lm	427 lm
DATA - TEST CENTRALNY AUTOMATYCZNY (MONITORING) / AUTOMATIC CENTRAL TEST (MONITORING) [ER or PRN]						
iTECH	W1 302 DATA (DATA 2)	2W / 1xLED	3h	M/NM	209 lm	209 lm
iTECH	W1 102 COLD DATA (DATA 2)	2W / 1xLED	1h	M/NM	209 lm	209 lm
iTECH	W1 302 COLD DATA (DATA 2)	2W / 1xLED	3h	M/NM	209 lm	209 lm
iTECH	W2 105 DATA (DATA 2)	5W / 2xLED	1h	M/NM	201 lm	427 lm
iTECH	W2 305 DATA (DATA 2)	5W / 2xLED	3h	M/NM	201 lm	427 lm
iTECH	W2 105 COLD DATA (DATA 2)	5W / 2xLED	1h	M/NM	201 lm	427 lm
CB - CENTRALNA BATERIA / CENTRAL BATTERY [ER or PRN]						
iTECH	W1 02 CBm	2W / 1xLED	-	-	209 lm	209 lm
iTECH	W2 05 CBm	5W / 2xLED	-	-	427 lm	427 lm

NM - praca awaryjna / non maintained
M - praca sieciowo-awaryjna / maintained

ITECH Z

wyznaczanie kierunku ewakuacji (znak ewakuacji)
evacuation road direction (evacuation sign)

<p>Wymiary [mm] Dimensions [mm]</p> <p>max 4 m</p> <p>175</p> <p>50</p> <p>ø 155</p>	<p>Montaż Mounting</p>
<p>19,5 x 20 x 7 [cm]</p> <p>Ilość opakowań: quantity of boxes: 400 szt./pcs</p>	

wymiary piktogramu
dimensions of pictogram: 306 x 156 mm

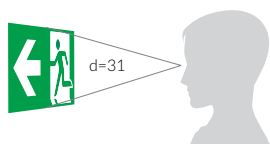

Piktogramy do opraw oświetlenia ewakuacyjnego, zgodnie z normą PN-EN ISO 7010
Pictograms for evacuation lighting fittings – according to PN-EN ISO 7010



Typ Type	Model Model	Źródło światła Light source	Czas Time	Tryb pracy Mode	Luminancja Luminance
ST – TEST RĘCZNY / MANUAL TEST [S]					
ITECH Z	E2 301 ST	LED	3 h	M	> 2 cd/m ²
AT – TEST AUTOMATYCZNY / SELFTEST (AUTOTEST) [P]					
ITECH Z	E2 301 AT	LED	3 h	M	> 2 cd/m ²
DATA – TEST CENTRALNY AUTOMATYCZNY (MONITORING) / AUTOMATIC CENTRAL TEST (MONITORING) [ER or PRN]					
ITECH Z	E2 301 DATA (DATA 2)	LED	3 h	M	> 2 cd/m ²
CB – CENTRALNA BATERIA / CENTRAL BATTERY [ER or PRN]					
ITECH Z	E2 01 CB	LED	-	-	> 2 cd/m ²

M – praca sieciowo-awaryjna / maintained
N – wersja natynkowa / surface mounted
P – wersja podtynkowa / recessed mounted